

Geometry

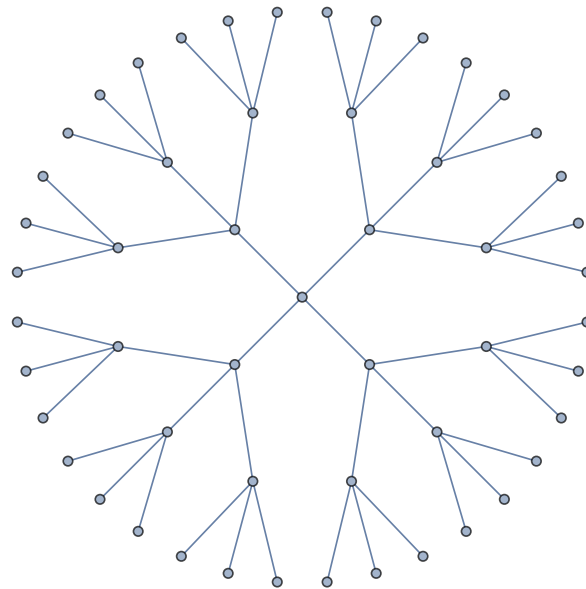

JOUNI PARKKONEN

LECTURES AT THE UNIVERSITY OF JYVÄSKYLÄ

FALL SEMESTER 2020

Contents

I	Elements	1
1	Geodesic metric spaces	3
1.1	Metric spaces	3
1.2	Isometric embeddings and isometries	4
1.3	Geodesics	5
1.4	Metric graphs	7
1.5	Triangles	10
	Exercises	11
2	Euclidean geometry	13
2.1	Euclidean space	13
2.2	Euclidean triangles	13
2.3	Isometries of \mathbb{E}^n	15
	Exercises	18
3	Spherical geometry	21
3.1	The sphere	21
3.2	More on cosine and sine laws	24
3.3	Isometries of \mathbb{S}^n	25
3.4	Triangles in the sphere	26
3.5	Some elementary Riemannian geometry on \mathbb{S}^2	29
	Exercises	31
4	Hyperbolic space	33
4.1	Minkowski space	33
4.2	The orthogonal group of Minkowski space	35
4.3	Hyperbolic space	39
4.4	Isometries of \mathbb{H}^n	42
4.5	Triangles in \mathbb{H}^n	46
	Exercises	48
5	Models of hyperbolic space	49
5.1	Klein's model	49

5.2	Poincaré's ball model	51
5.3	The upper halfspace model	54
5.4	Triangles in \mathbb{H}^n (part 2)	58
5.5	Isometries of the upper halfspace model	58
5.6	Generalized triangles in \mathbb{H}^n	63
5.7	Halfspaces and polytopes	64
5.8	Riemannian metrics, area and volume	65
	Exercises	66
A	Inversive geometry	69
A.1	One-point compactification	69
A.2	Inversions	70
	Exercises	72
II	Negatively curved spaces	73
6	Gromov-hyperbolic spaces	75
6.1	δ -hyperbolic spaces	75
6.2	Gromov product	77
6.3	Approximation of paths by geodesics	80
	Exercises	81
7	Quasi-isometries and hyperbolicity	83
7.1	Quasi-isometric embeddings and quasi-isometries	83
7.2	Stability of quasigeodesics	85
7.3	Quasitriangles and the proof of Theorem 7.8	89
7.4	Hyperbolic groups	90
7.5	Group actions and the Švarc-Milnor lemma	92
	Exercises	95
8	Boundary at infinity	97
8.1	Asymptotic rays	97
8.2	The boundary at infinity	100
8.3	The boundary at infinity of a simplicial tree	101
	Exercises	103
9	Topology of the boundary at infinity	105
9.1	Generalized rays	105
9.2	The boundary at infinity and rays with a fixed origin	106
9.3	Visibility	107
9.4	Quasi-isometries and the boundary at infinity	108
9.5	A topology on $X \cup \partial_\infty X$	110
	Exercises	112
10	CAT(-1) spaces	115
10.1	Comparison geometry	115
10.2	CAT(κ) spaces	117

Exercises	120
11 The boundary at infinity of a $\text{CAT}(-1)$-space	121
11.1 Some hyperbolic geometry	121
11.2 Asymptotic rays	122
11.3 The Busemann cocycle	123
11.4 Gromov product in the boundary at infinity	126
Exercises	128
B Complements on topology	129
B.1 Topology of compact convergence	129
B.2 The theorems of Arzelà and Ascoli	129
B.3 Quotient mappings	130
Exercises	131
C Projects	133
C.1 The theorem of Arzelà and Ascoli	133
C.2 The 4-point condition	133
C.3 Metrically convex spaces	134
Bibliography	135

Introduction

will be written a bit later.

Notations and conventions

For any mapping $f: X \rightarrow X$, the *fixed point set* of f is

$$\text{fix } f = \{x \in X : f(x) = x\}.$$

If a group G acts on a space X and A is a nonempty subset of X , the *stabilizer* of A in G is

$$\text{Stab}_G A = \{g \in G : gA = A\}.$$

Clearly, stabilisers are subgroups of G .

- $\mathbb{N} = \{0, 1, 2, \dots\}$.
- $\#(A) \in \mathbb{N} \cup \{\infty\}$ cardinality of A .
- $A - B = \{a \in A : a \notin B\}$.
- $f|_A$ is the restriction of mapping $f: X \rightarrow Y$ to a subset $A \subset X$, $f|_A(a) = f(a)$ for all $a \in A$.
- $A \subsetneq B$ means A is a *proper subset* of B : $A \subset B$ and $A \neq B$.
- $\text{diag}(a_1, a_2, \dots, a_n)$ is the $n \times n$ -diagonal matrix with a_1, a_2, \dots, a_n on the diagonal.
- $\text{diag}(A_1, A_2, \dots, A_n)$ is the block diagonal matrix with square matrices A_1, A_2, \dots, A_n on the diagonal.
- $I_n = \text{diag}(1, 1, \dots, 1)$.
- ${}^t A$ is the transpose of a matrix A .
- $\text{Homeo}(X)$ the group of homeomorphisms of a topological space X .
- $\text{Isom}(X)$ the group of isometries of a metric space X .
- $C(X, Y)$ space of continuous functions from a topological space X to a metric space Y with the topology of compact convergence.

Definitions are boxed like this and not numbered.

A box like this has some remark or convention that is good to notice!

Part I

Elements

Chapter 1

Geodesic metric spaces

In this chapter, we collect background material on metric spaces, in particular on geodesic spaces. We also introduce some convenient terminology to be used throughout the course.

1.1 Metric spaces

We refer to [Bou1, Bou2, Mun] for the theory of metric (and topological) spaces. In this section, for the convenience of the reader, we collect some standard definitions, notations and examples.

Let $X \neq \emptyset$. A function $d: X \times X \rightarrow [0, \infty[$ is a *metric* in X if

- (1) $d(x, x) = 0$ for all $x \in X$ and $d(x, y) > 0$ if $x \neq y$,
- (2) $d(x, y) = d(y, x)$ for all $x, y \in X$, and
- (3) $d(x, y) \leq d(x, z) + d(z, y)$ for all $x, y, z \in X$ (the *triangle inequality*).

The pair (X, d) is a *metric space*.

Example 1.1. (a) Any normed space is a metric space. In particular, the space \mathbb{R}^n with the Euclidean distance is a metric space.

(b) The circle \mathbb{S}^1 with the distance between two points defined as their angle as vectors in \mathbb{E}^2 is a metric space, see Section 3.1 for details and generalisations.

(c) Let $X \neq \emptyset$. The discrete metric $d: X \times X \rightarrow [0, \infty[$ is defined by setting $d(x, x) = 0$ for all $x \in X$ and $d(x, y) = 1$ for all $x, y \in X$ if $x \neq y$.

Open and closed balls in a metric space, continuity of maps between metric spaces and other “metric properties” are defined in the usual manner. In particular, if X is a metric space, $x \in X$ and $r > 0$,

$$B(x_0, r) = B_d(x_0, r) = \{x \in X : d(x, x_0) < r\}$$

is the open ball of radius r and

$$\overline{B}(x_0, r) = \overline{B}_d(x_0, r) = \{x \in X : d(x, x_0) \leq r\}$$

is the closed ball of radius r .

A metric space is *proper* if its closed balls are compact.

Euclidean spaces are proper by the theorem of Heine and Borel.

1.2 Isometric embeddings and isometries

If (X_1, d_1) and (X_2, d_2) are metric spaces, then a map $i: X \rightarrow Y$ is an *isometric embedding*, if

$$d_2(i(x), i(y)) = d_1(x, y)$$

for all $x, y \in X_1$.

A map $i: X \rightarrow Y$ is a *locally isometric embedding* if each point $x \in X$ has a neighbourhood U such that the restriction of i to U is an isometric embedding.

Lemma 1.2. (a) *Isometric embeddings are continuous injective mappings.*

(b) *If $f: X \rightarrow Y$ and $g: Y \rightarrow Z$ are isometric embeddings, then $g \circ f$ is an isometric embedding.*

(b) *If $f: X \rightarrow Y$ and $g: Y \rightarrow Z$ are locally isometric embeddings, then $g \circ f$ is a locally isometric embedding.*

Proof. Exercise. □

If an isometric embedding $i: X \rightarrow Y$ is a bijection, then it is called an *isometry* between X and Y .

An isometry $i: X \rightarrow X$ is called an isometry of X .

We consider two isometric metric spaces to be two *models* of the same abstract metric space. If (X, d) is a metric space, Y is a set and $f: Y \rightarrow X$ is a bijection, then we get a metric in Y by setting $d_f(y_1, y_2) = d(f(y_1), f(y_2))$ for all y_1, y_2 . Now $f: (Y, d_f) \rightarrow (X, d)$ is an isometry and it is natural to think of (Y, d_f) as a model of (X, d) . We will see concrete examples in Chapter 5 when we consider models of hyperbolic space.

Proposition 1.3. *The isometries of a metric space X form a group $\text{Isom}(X)$ with the composition of mappings as the group law.*

Proof. Exercise. □

Let X be a metric space. The *stabilizer* of a point $x \in X$ is

$$\text{Stab } x = \{F \in \text{Isom } X : F(x) = x\}.$$

Proposition 1.4. *Let X be a metric space and let $x \in X$. Then $\text{Stab } X$ is a subgroup of $\text{Isom } X$.*

Proof. Exercise. □

Example 1.5. We will see in section 2.3 that the *Euclidean group*

$$E(n) = \{x \mapsto Ax + b : A \in O(n), b \in \mathbb{R}^n\}$$

is the group of isometries of the n -dimensional Euclidean space \mathbb{E}^n .¹ The stabilizer of $0 \in \mathbb{E}^n$ is $O(n)$.

If a group G acts on a space X , and x is a point in X , the set

$$G(x) = \{g(x) : g \in G\}$$

is the G -orbit of x . The action of a group is said to be *transitive* if $G(x) = X$ for some (and therefore for any) $x \in X$.

A more elementary way to express this is that a group G acts transitively on X if for all $x, y \in X$ there is some $g \in G$ such that $g(x) = y$.

1.3 Geodesics

In this section, we give names to a particularly important class of isometric and locally isometric embeddings and use these objects to define the class of metric spaces that plays a central role in this course.

Let $I \subset \mathbb{R}$ be an interval. A (locally) isometric embedding $i: I \rightarrow X$ is a (*local*) *geodesic*. More precisely, it is

- (1) a (*locally*) *geodesic segment*, if $I \subset \mathbb{R}$ is a (closed) bounded interval,
- (2) a (*locally*) *geodesic ray*, if $I = [0, +\infty[$, and
- (3) a (*locally*) *geodesic line*, if $I = \mathbb{R}$.

Note that in Riemannian geometry, the definition of a geodesic is different from the above: If (M, g) is a Riemannian manifold and I is an open interval, a *Riemannian geodesic* $\gamma: I \rightarrow M$ is a differentiable path whose acceleration is 0. If $\gamma: I \rightarrow M$ is a Riemannian geodesic, then there is some $c > 0$ and such that the mapping $t \mapsto g(\frac{t}{c})$ is a local geodesic according to our definition.

If $\gamma: [a, b] \rightarrow X$ is a path, then γ *connects* the points $\gamma(a)$ to $\gamma(b)$.

If γ is a geodesic segment that connects $x \in X$ to $y \in X$, the points x and y are the *endpoints* of γ .

Sometimes it is convenient to use more precise terminology and, for instance, refer to the endpoint $j(0)$ as the *origin* of j and to the other endpoint as the *terminal point* or the *terminus* of j .

¹See section 2.1.

A metric space (X, d) is a *geodesic metric space*, if for any $x, y \in X$ there is a geodesic segment that connects x to y .

Example 1.6. Any normed space is a geodesic metric space: Let $(V, \|\cdot\|)$ be a normed space. For any two distinct points $x, y \in V$, the map

$$t \mapsto x + t \frac{y - x}{\|y - x\|},$$

is a geodesic line that passes through the points x and y . Indeed, for any $s, t \in \mathbb{R}$, we have

$$\|j(t) - j(s)\| = \left\| x_0 + t \frac{y - x}{\|y - x\|} - \left(x_0 + s \frac{y - x}{\|y - x\|} \right) \right\| = \left\| (t - s) \frac{y - x}{\|y - x\|} \right\| = |t - s|.$$

The restriction $j|_{[0, \|x-y\|]}$ is a geodesic segment that connects x to y .

Example 1.7. It can be shown that $h_\alpha(s, t) = |s - t|^\alpha$ is a metric in \mathbb{R} if $0 < \alpha \leq 1$. The metric space (\mathbb{R}, h_α) is homeomorphic to \mathbb{R} with the usual metric given by the expression h_1 but it is not a geodesic metric space if $0 < \alpha < 1$.

A metric space (X, d) is *uniquely geodesic*, if for any $x, y \in X$ there is exactly one geodesic segment that connects x to y .

If X is a uniquely geodesic metric space and $x, y \in X$, $x \neq y$, we denote the (image of the) unique geodesic segment connecting x to y by $[x, y]$.^a

^aThis notation is often used even in spaces that are not uniquely geodesic.

Proposition 1.8. Any inner product space is a uniquely geodesic metric space.

Proof. Let V be an inner product space and let $x, y \in V$. We show that j constructed in Example 1.6 is the only geodesic segment that connects x to y .²

Let $x, y, z \in V$ such that $\|x - z\| + \|z - y\| = \|x - y\|$. We may assume for simplicity that $x = 0$. Squaring, the equation $\|y - z\| = \|y\| - \|z\|$, we get after simplification $(y|z) = \|y\|\|z\|$ and the claim follows from Cauchy's inequality. \square

Let X be a uniquely geodesic metric space. A nonempty subset $K \subset X$ is *convex* if $[x, y] \subset K$ for all $x, y \in K$.

A convex set $K \subset X$ is *strictly convex* if $[x, y] \cap \partial K = \{x, y\}$ for any $x, y \in K$.

Example 1.9. A normed space is uniquely geodesic if and only if its unit ball is strictly convex. See [BH, Prop. I.1.6]. Thus, for example the normed spaces $(\mathbb{R}^2, \|\cdot\|_p)$ with

$$\|x\|_p = \sqrt[p]{x_1^p + x_2^p}$$

are uniquely geodesic metric spaces if $1 < p < \infty$.

There are plenty of examples of metric spaces arising from normed spaces that are not uniquely geodesic. For example, the unit balls of the norms

$$\|x\|_\infty = \max\{|x_1|, |x_2|\}$$

²up to replacing the interval of definition $[0, \|x - y\|]$ of the geodesic by $[a, a + \|x - y\|]$ for some $a \in \mathbb{R}$.

and

$$\|x\|_\infty = |x_1| + |x_2|$$

in \mathbb{R}^2 are not strictly convex.

It is easy to check that, among many others, the mappings $j_1, j_2: [0, 1] \rightarrow (\mathbb{R}^2, d_\infty)$ defined by $j_1(t) = t(1, 0)$ and

$$j_2(t) = \begin{cases} t(1, 1), & \text{if } 0 \leq t \leq \frac{1}{2}, \\ (t, 1 - t), & \text{if } \frac{1}{2} \leq t \leq 1 \end{cases}$$

are both geodesic segments in (\mathbb{R}^2, d_∞) connecting 0 to $(1, 0)$.

Note that the inverse path of j is a geodesic that connects y to x so even in a uniquely geodesic space there are two geodesic segments with endpoints x and y if we do not specify the order of the endpoints.

In certain contexts,³ it is convenient to use mappings that multiply distances with a fixed constant.

Let X be a metric space, let $I \subset \mathbb{R}$ be a compact interval and let $K > 0$. A mapping $j: I \rightarrow X$ is an *affinely reparametrized geodesic* if $d(j(s), j(t)) = K|s - t|$ for all $s, t \in I$.

1.4 Metric graphs

Metric graphs and, in particular, metric trees are important examples in this course. The definition, based on see [Ser, Sect. 2.1], is somewhat involved.

Let $E\mathbb{X}$ and $V\mathbb{X}$ be two nonempty sets and let $o, t: E\mathbb{X} \rightarrow V\mathbb{X}$ and $\bar{\cdot}: E\mathbb{X} \rightarrow E\mathbb{X}$ be mappings that satisfy $\bar{e} \neq e$, $\bar{\bar{e}} = e$ and $o(\bar{e}) = t(e)$ for all $e \in E\mathbb{X}$. The quintuple $\mathbb{X} = (V\mathbb{X}, E\mathbb{X}, t, o, \bar{\cdot})$ is a *graph*.

The sets $E\mathbb{X}$ and $V\mathbb{X}$, called the *set of vertices* and the *set of edges* of \mathbb{X} .

The elements $o(e)$, $t(e)$ and \bar{e} are called the *initial vertex*, the *terminal vertex* and the *opposite edge* of an edge $e \in E\mathbb{X}$. The quotient of $E\mathbb{X}$ by the equivalence relation induced by the involution $e \mapsto \bar{e}$ is called the set of *nonoriented edges* of \mathbb{X} .

The cardinality of the preimage $o^{-1}(v)$ is the *degree* $\deg v$ of the vertex $v \in V\mathbb{X}$. If $\deg: \mathbb{X} \rightarrow \mathbb{N}$ is a constant mapping, then \mathbb{X} is a *regular graph*.

Note that we make no further assumptions on the cardinalities of the sets of vertices and edges that the fact that these sets are not empty.

Often, graphs are defined in a different way, taking the set of nonoriented edges to be a set consisting of pairs of distinct vertices. Furthermore, our construction allows for *loops* where $o(e) = t(e)$ for some edge e .

A graph is not a geometrical or topological object but one can associate natural spaces to it as follows. Recall that an equivalence relation \sim is finer than \simeq if $x \sim y$ implies $x \simeq y$.

³See the proof of Theorem 7.10 and the definition of metric convexity in section C.3.

The *topological realisation* $|\mathbb{X}|$ of a graph \mathbb{X} is the topological space obtained from the disjoint union of the family $(I_e)_{e \in E\mathbb{X}}$ of closed unit intervals I_e and $V\mathbb{X}$ by the finest equivalence relation that identifies intervals corresponding to an edge and its opposite edge by the map $t \mapsto 1 - t$ and identifies $0 \in I_e$ with $o(e) \in V\mathbb{X}$.

More precisely, let $\coprod_{e \in E\mathbb{X}} I_e$ be the disjoint union of a family $(I_e)_{e \in E\mathbb{X}}$ of closed unit intervals I_e with the topology of the disjoint union.⁴ Let \sim be the equivalence relation in $\coprod_{e \in E\mathbb{X}}$ generated by the identifications $(t, e) \sim (1 - t, \bar{e})$ for all $t \in [0, 1]$ and all $e \in E\mathbb{X}$ and $(0, e) \sim (0, e')$ if and only if $o(e) = o(e') \in V\mathbb{X}$.

A graph is *connected* if its topological realisation is path connected as a topological space. A connected graph is a *tree* if its topological realisation is uniquely arcwise connected.^a

^aRecall that the image of an injective path defined on a compact interval is an *arc*. A topological space X is *uniquely arcwise connected* if for any two distinct points $x, y \in X$ there is a unique arc $|\gamma|$ whose endpoints are x and y .

Example 1.10. (1) If $V\mathbb{X} = \mathbb{Z}$, $E\mathbb{X} = \mathbb{Z} \times \{0, 1\}$, $o(k, j) = k + j$, $t(k, j) = k + 1 - j$ and $(k, j) = (k, 1 - j)$, then it is easy to check using Figure 1.1 that the topological realization of \mathbb{X} is homeomorphic to \mathbb{E}^1 . If we replace \mathbb{Z} by \mathbb{N} in the construction, we obtain a graph \mathbb{X}' whose geometric realization is homeomorphic to $[0, \infty[$.

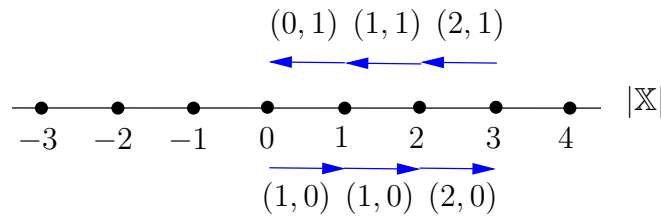

Figure 1.1 — \mathbb{E}^1 as a metric graph

(2) Let $A \neq \emptyset$ be any nonempty set and let $V\mathbb{X} = \{0\} \times A$ and $E\mathbb{X} = A \times \{0, 1\}$. Let $o(a, 0) = 0 = t(a, 1)$ and $o(a, 1) = a = t(a, 0)$ for all $a \in A$ and define $(a, k) = (a, 1 - k)$ for all $a \in A$. If A is an infinite set, for example $A = \mathbb{S}^1$, the geometric realization of A is not locally compact at the vertex 0.

(3) Often, we describe a graph more informally, for example by drawing a picture of the geometric realization or a sufficiently large part of it if the structure repeats itself in a reasonable manner.

A *metric graph* (\mathbb{X}, λ) is a pair consisting of a connected graph \mathbb{X} and *edge length map* $\lambda : E\mathbb{X} \rightarrow]0, +\infty]$ such that $\lambda(\bar{e}) = \lambda(e)$.

A *simplicial graph* \mathbb{X} is a metric graph whose edge length map is constant equal to 1.

Let (\mathbb{X}, λ) be a metric graph and let $\pi_{\mathbb{X}} : \coprod_{e \in E\mathbb{X}} I_e \rightarrow |\mathbb{X}|$ be the canonical projection. A continuous mapping $c : [0, 1] \rightarrow |\mathbb{X}|$ is a *piecewise linear path* if there is a subdivision

⁴This is the finest topology for which all the natural injections $I_e \hookrightarrow \coprod_{e \in E\mathbb{X}} I_e$ are continuous.

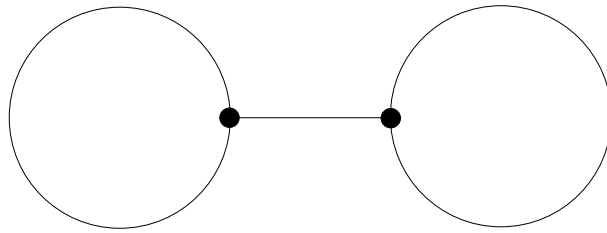

Figure 1.2 — The topological realization of a graph with two vertices and three undirected edges that has two loops.

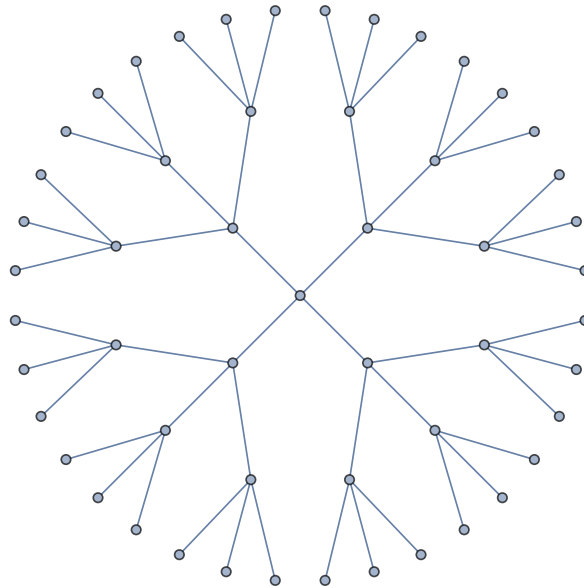

Figure 1.3 — Part of the geometric realization of a regular infinite simplicial tree such that the degree of each vertex is 4. Imagine all the branches extending indefinitely with the same branching at every vertex.

$0 = t_0 < t_1 < \dots < t_n = 1$ of $[0, 1]$, a collection of edges $e_1, \dots, e_n \in E\mathbb{X}$ and affine mappings $c_i: [t_{i-1}, t_i] \rightarrow I_{e_i}$ such that $c|_{[t_{i-1}, t_i]} = \pi_{\mathbb{X}} \circ c_i$. The *length* of c is

$$\ell_{\lambda}(c) = \sum_{i=1}^n |c_i(t_i) - c_i(t_{i-1})| \lambda(e_i).$$

If $x, y \in |\mathbb{X}|$, let

$$\text{PL}(x, y) = \{c: [0, 1] \rightarrow |\mathbb{X}| : c \text{ piecewise linear, } c(0) = x, c(1) = y\}.$$

Proposition 1.11. *Let (\mathbb{X}, λ) be a metric graph such that any two points in $|\mathbb{X}|$ can be connected by a piecewise linear path and λ has a positive lower bound. The expression*

$$d_{\lambda}(x, y) = \inf_{c \in \text{PL}(x, y)} \ell_{\lambda}(c)$$

defines a metric on the topological realization of \mathbb{X} .

Proof. Exercise. □

From now on, we assume that the edge length map of a metric graph has a positive lower bound.

The above assumption could have been taken to be part of the definition of a metric tree without restricting the generality of the construction in any essential way even though it is easy to construct examples of metric trees without such a lower bound where the above construction yields a metric.

Let (\mathbb{X}, λ) be a metric graph such that λ has a positive lower bound. The *geometric realisation* of (\mathbb{X}, λ) is the metric space $(|\mathbb{X}|, d_\lambda)$.

The metric space X determines (\mathbb{X}, λ) up to subdivisions of edges, hence we will often not make a strict distinction between X and (\mathbb{X}, λ) . In particular, we identify $V\mathbb{X}$ with its image in X and we will refer to convex subsets of (\mathbb{X}, λ) as convex subsets of X , etc.

A uniquely arcwise connected geodesic metric space is an \mathbb{R} -tree.

Example 1.12. (a) For any $x, y \in \mathbb{R}$, let

$$d_{\text{SNCF}}(x, y) = \begin{cases} \|x - y\| & \text{if } x \text{ and } y \text{ are linearly dependent,} \\ \|x\| + \|y\| & \text{otherwise.} \end{cases}$$

The *French railroad space* $(\mathbb{R}^2, d_{\text{SNCF}})$ is an \mathbb{R} -tree.⁵

(2) Figure 1.3 shows a simplicial tree.

1.5 Triangles

The definitions of negatively curved spaces in Chapters 6 and 10 are based on the properties of triangles and we will also treat classical properties of triangles in the Euclidean, spherical and hyperbolic spaces. A precise definition of this fundamental object is therefore in order:

Let X be a metric space. A *triangle* in X is a triple $\Delta = \{j_1, j_2, j_3\}$ of geodesic segments such that the terminus of j_i is the origin of j_{i+1} with the index i considered cyclically mod 3.

The geodesic segments j_1, j_2 and j_3 are the *sides* of Δ .

A triangle Δ is *degenerate* if it is contained in the image of one of its sides.

The endpoints of the geodesic arcs j_1, j_2 and j_3 are the *vertices* of Δ .

A triangle Δ in a uniquely geodesic metric space is determined by its vertices but in general,⁶ one has to specify the sides.

⁵SNCF=Société nationale des chemins de fer français is the French national railroad company.

⁶See Example 1.9

If X is a uniquely geodesic metric space and $x, y, z \in X$, then

$$\Delta(x, y, z) = \{[x, y], [y, x], [z, x]\}$$

is the *triangle with vertices* x, y and z .

If X is a geodesic metric space and three points $A, B, C \in X$ are the vertices of a triangle, we denote the lengths of the sides with endpoints A and B , B and C and C and A , in the corresponding order, by c, a and b . If the angles at the vertices are defined,^a the angles between the sides at the vertices A, B and C be α, β and γ . See Figure 2.1.

^afor example in Chapters 2, 3 and 4

Exercises

1.1. Prove Propositions 1.3 and 1.4.

1.2. Fill in the details in Example 1.7.

1.3. Prove Proposition 1.11. Why do we assume that the length function has a positive lower bound?

1.4. Prove that $(\mathbb{R}^2, d_{\text{SNCF}})$ is not a proper metric space. Describe the isometry group of $(\mathbb{R}^2, d_{\text{SNCF}})$.

1.5. For any $x, y \in \mathbb{R}^2$, let

$$d(x, y) = \begin{cases} |x_2| + |x_1 - y_1| + |y_2| & , \text{ if } x_1 \neq y_1, \\ |x_2 - y_2| & , \text{ if } x_1 = y_1, \end{cases}$$

(a) Prove that (\mathbb{R}^2, d) is an \mathbb{R} -tree.

(b) Draw the sphere $\partial B(0, 1)$ of (\mathbb{R}^2, d) . Is it compact or connected?

Let $[a, b] \subset \mathbb{R}$ be a compact interval. An ordered finite sequence

$$\sigma = (a = \sigma_0 < \sigma_1 < \cdots < \sigma_n = b)$$

is a *partition* of $[a, b]$. Let $\mathcal{P}_{a,b}$ be the *set of partitions* of $[a, b]$.

Let X be a metric space and let $\gamma: [a, b] \rightarrow X$ be a path. The *variation* of γ with respect to a partition $\sigma = (a = \sigma_0 < \sigma_1 < \cdots < \sigma_n = b)$ is

$$V_a^b(\gamma, \sigma) = \sum_{i=1}^n d(\gamma(\sigma_i), \gamma(\sigma_{i-1})).$$

The *length* of γ is its *total variation*

$$\ell(\gamma) = V_a^b(\gamma) = \sup_{\sigma \in \mathcal{P}_{a,b}} V_a^b(\gamma, \sigma).$$

- 1.6.** Let X be a metric space and let $\gamma: [0, b] \rightarrow X$ be a geodesic segment.
- (a) Compute the length of γ .
 - (b) Prove that γ is a shortest path from $\gamma(0)$ to $\gamma(b)$.

Chapter 2

Euclidean geometry

This chapter collects background information on Euclidean spaces. Most of this should be known in some form from linear algebra and elementary geometry.

2.1 Euclidean space

As we use various different structures on the space \mathbb{R}^n , it is convenient to have a fixed notation for the situation where we use the standard Euclidean structure. The notation \mathbb{R}^n therefore does not carry the Euclidean structure, it is just the n -fold Cartesian product of \mathbb{R} , and we usually consider it with the standard structure of a vector space over \mathbb{R} .

Let us denote the *Euclidean inner product* of \mathbb{R}^n by

$$(x | y) = \sum_{i=1}^n x_i y_i .$$

The *Euclidean norm* $\|x\| = \sqrt{(x|x)}$ defines the *Euclidean distance* $d(x, y) = \|x - y\|$. The triple $\mathbb{E}^n = (\mathbb{R}^n, (\cdot | \cdot), \|\cdot\|)$ is n -dimensional *Euclidean space*.

Proposition 2.1. *Euclidean space is a uniquely geodesic metric space.*

Proof. See Proposition 1.8 □

2.2 Euclidean triangles

The first two results are classical formulae that connect the side lengths and angles of triangles in Euclidean space.

Proposition 2.2 (The Euclidean law of cosines). *The relation*

$$c^2 = a^2 + b^2 - 2ab \cos \gamma$$

holds for all triangles in \mathbb{E}^n .

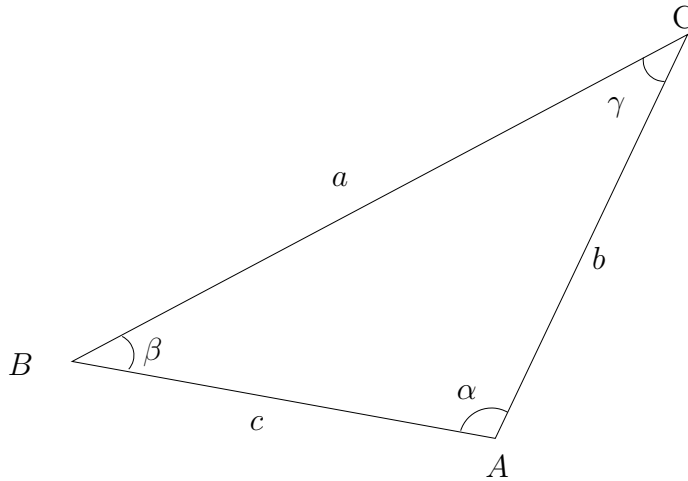

Figure 2.1 — A triangle in Euclidean space.

Proof. The proof is linear algebra:

$$\begin{aligned} c^2 &= \|B - A\|^2 = \|B - C + C - A\|^2 = b^2 + 2(B - C | C - A) + a^2 \\ &= b^2 + 2(B - C | C - A) + a^2 = b^2 - 2ab \cos \gamma + a^2. \end{aligned} \quad \square$$

Proposition 2.3 (The Euclidean law of sines). *The relation*

$$\frac{a}{\sin \alpha} = \frac{b}{\sin \beta} = \frac{c}{\sin \gamma}$$

holds for all triangles in \mathbb{E}^n .

Proof. Exercise. □

The following result will be useful in Chapter 10 when we discuss comparison geometry and CAT(-1) spaces. The content is this: Given any three positive numbers that satisfy the conditions arising from the triangle inequality to be the sides of a triangle in a geodesic metric space, there is a triangle in \mathbb{E}^2 with precisely these side lengths.

Proposition 2.4. *Let $a, b, c > 0$ and assume that $a + b \geq c$, $a + c \geq b$ and $b + c \geq a$. There is a triangle in \mathbb{E}^2 with side lengths a , b and c .*

Proof. The inequality $a + b \geq c$ implies $\frac{a^2 + b^2 - c^2}{2ab} \geq -1$ and the inequality $a + c \geq b$ implies $\frac{a^2 + b^2 - c^2}{2ab} \leq 1$. Thus, we can solve the equation $c^2 = a^2 + b^2 - 2ab \cos \gamma$ to find $\gamma \in [0, \pi]$. Placing two segments of lengths a and b starting at 0 with the angle γ at the vertex 0 determines a triangle in \mathbb{E}^2 . The Euclidean law of cosines implies that the length of the third edge is c . □

Proposition 2.5. *The sum of the angles of a triangle in \mathbb{E}^2 is π .*

Proof. There are many different proofs, here is one that uses complex numbers: Note that

$$\frac{C - A}{B - A} = \left\| \frac{C - A}{B - A} \right\| e^{i\alpha}, \quad \frac{A - B}{C - B} = \left\| \frac{A - B}{C - B} \right\| e^{i\beta}, \quad \frac{A - C}{B - C} = \left\| \frac{B - C}{A - C} \right\| e^{i\gamma}.$$

The product of the left sides of these equations is -1 , and therefore, $e^{i(\alpha+\beta+\gamma)} = -1$. Thus, $\alpha + \beta + \gamma = \pi + k2\pi$ for some $k \in \mathbb{Z}$. As $0 \leq \alpha, \beta, \gamma \leq \pi$ and at most one of them can be π , we get the claim. \square

2.3 Isometries of \mathbb{E}^n

We will now study the isometries of Euclidean space more closely.

The (*Euclidean*) *orthogonal group* of dimension n is

$$\begin{aligned} \mathrm{O}(n) &= \{A \in \mathrm{GL}_n(\mathbb{R}) : (Ax \mid Ay) = (x \mid y) \text{ for all } x, y \in \mathbb{E}^n\} \\ &= \{A \in \mathrm{GL}_n(\mathbb{R}) : A^T A = I_n\}. \end{aligned}$$

Recall the following basic result from linear algebra:

Lemma 2.6. *An $n \times n$ -matrix $A = (a_1, \dots, a_n)$ is in $\mathrm{O}(n)$ if and only if the vectors a_1, \dots, a_n form an orthonormal basis of \mathbb{E}^n .* \square

It is easy to check that elements of $\mathrm{O}(n)$ give isometries on \mathbb{E}^n for any $n \in \mathbb{N}$: Let $A \in \mathrm{O}(n)$ and let $x, y \in \mathbb{E}^n$. Now

$$\begin{aligned} d(Ax, Ay)^2 &= (Ax - Ay \mid Ax - Ay) = (A(x - y) \mid A(x - y)) \\ &= (A^T A(x - y) \mid x - y) = (x - y \mid x - y) \\ &= d(x - y)^2. \end{aligned}$$

For any $b \in \mathbb{R}^n$, let $t_b(x) = x + b$ be the translation by b . Again, it is easy to see that translations are isometries of \mathbb{E}^n . The *translation group* is

$$\mathrm{T}(n) = \{t_b : b \in \mathbb{R}^n\}.$$

Orthogonal maps and translations generate the *Euclidean group*

$$\mathrm{E}(n) = \{x \mapsto Ax + b : A \in \mathrm{O}(n), b \in \mathbb{R}^n\} = \mathrm{T}(n)\mathrm{O}(n)$$

which consists of isometries of \mathbb{E}^n .

Proposition 2.7. *$\mathrm{E}(n)$ acts transitively by isometries on \mathbb{E}^n . In particular, $\mathrm{Isom}(\mathbb{E}^n)$ acts transitively on \mathbb{E}^n .*

Proof. The Euclidean group of \mathbb{E}^n contains the group of translations $\mathrm{T}(n)$ as a subgroup. This subgroup acts transitively because for any $x, y \in \mathbb{R}^n$, we have $T_{y-x}(x) = y$. \square

Next, we want to prove that all isometries of Euclidean space \mathbb{E}^n are elements of the Euclidean group.

Theorem 2.8. $\mathrm{Isom}(\mathbb{E}^n) = \mathrm{E}(n)$.

The proof of this theorem and the introduction of the tools needed in the proof takes up the rest of this section.

An *affine hyperplane* of \mathbb{E}^n is a subset of the form

$$H = H(P, u) = P + u^\perp,$$

where $P, u \in \mathbb{E}^n$ and $\|u\| = 1$. The *reflection* in H is the map

$$r_H(x) = x - 2(x - P | u)u.$$

Lemma 2.9. *The definition of r_H is independent of the choice of $P \in H$.*

Proof. If $P, Q \in H$, then $P - Q \in u^\perp$. Thus,

$$x - 2(x - P | u)u = x - 2(x - P | u)u + 2(P - Q | u)u = x - 2(x - Q | u)u. \quad (2.1)$$

□

Reflections are very useful isometries, the following results give some of their basic properties.

Proposition 2.10. *Let H be an hyperplane in \mathbb{E}^n . Then*

- (1) $r_H \circ r_H$ is the identity.
- (2) $r_H \in \mathbf{E}(n)$. In particular, r_H is an isometry, and if $0 \in H$, then $r_H \in \mathbf{O}(n)$.
- (3) $d(r_H(x), y) = d(x, y)$ for all $x \in \mathbb{E}^n$ and all $y \in H$.
- (4) The fixed point set of r_H is H .

Proof. We will prove (3) and leave the rest as exercises. Let $x \in \mathbb{E}^n$ and $y \in H$. We have $r_H(x) = x - 2(x - y | u)u$, which implies

$$\begin{aligned} d(r_H(x), y)^2 &= (r_H(x) - y | r_H(x) - y) = (x - y - 2(x - y | u)u | x - y - 2(x - y | u)u) \\ &= (x - y | x - y) - 4(x - y | (x - y | u)u) + 4((x - y | u)u | (x - y | u)u) \\ &= (x - y | x - y) = d(x, y)^2. \end{aligned}$$

□

The *bisector* of two distinct points p and q in \mathbb{E}^n is the affine hyperplane

$$\text{bis}(p, q) = \{x \in \mathbb{E}^n : d(x, p) = d(x, q)\} = \frac{p + q}{2} + (p - q)^\perp.$$

Lemma 2.11. *If $p, q \in \mathbb{E}^n$, $p \neq q$, then*

$$\text{bis}(p, q) = \frac{p + q}{2} + (p - q)^\perp.$$

Proof. Exercise. □

Proposition 2.12. (1) *If $r_H(x) = y$ and $x \notin H$, then $H = \text{bis}(x, y)$.*

(2) *If $p, q \in \mathbb{E}^n$, $p \neq q$, then $r_{\text{bis}(p, q)}(p) = q$.*

(3) *Let $\phi \in \text{Isom}(\mathbb{E}^n)$, $\phi \neq \text{id}$. If $a \in \mathbb{E}^n$, $\phi(a) \neq a$, then the fixed points of ϕ are contained in $\text{bis}(a, \phi(a))$.*

(4) *Let $\phi \in \text{Isom}(\mathbb{E}^n)$, $\phi \neq \text{id}$. If H is a hyperplane such that $\phi|_H$ is the identity, then $\phi = r_H$.*

Proof. (1) follows from Proposition 2.10(3).

(2) From the definitions we get

$$r_{\text{bis}(p,q)}(p) = p - 2\left(p - \frac{p+q}{2} \mid p - q\right) \frac{p - q}{\|p - q\|^2} = q.$$

(3) If $\phi(b) = b$, then $d(a, b) = d(\phi(a), \phi(b)) = d(\phi(a), b)$, so that $b \in \text{bis}(a, \phi(a))$.

(4) Let $a \notin H$ be a point that is not fixed by ϕ . Claim (3) implies that H is contained in $\text{bis}(a, \phi(a))$ and as the dimensions agree, we have $H = \text{bis}(a, \phi(a))$. Thus, by Claim (2), $r_H(a) = \phi(a)$. But this holds for all $a \notin H$. As $r_H|_H = \phi_H = \text{id}_H$, we have $\phi = r_H$. \square

The idea of the proof of Theorem 2.8 is to show that each isometry of \mathbb{E}^n is the composition of reflections in affine hyperplanes. In order to do this, we show that the isometry group has a stronger transitivity property than what was noted above.

Proposition 2.13. *Let $p_1, p_2, \dots, p_k, q_1, q_2, \dots, q_k \in \mathbb{E}^n$ be points that satisfy*

$$d(p_i, p_j) = d(q_i, q_j)$$

for all $i, j \in \{1, 2, \dots, k\}$. Then, there is an isometry $\phi \in E(n) \leq \text{Isom}(\mathbb{E}^n)$ such that $\phi(p_i) = q_i$ for all $i \in \{1, 2, \dots, k\}$. Furthermore, the isometry ϕ is the composition of at most k reflections in affine hyperplanes.

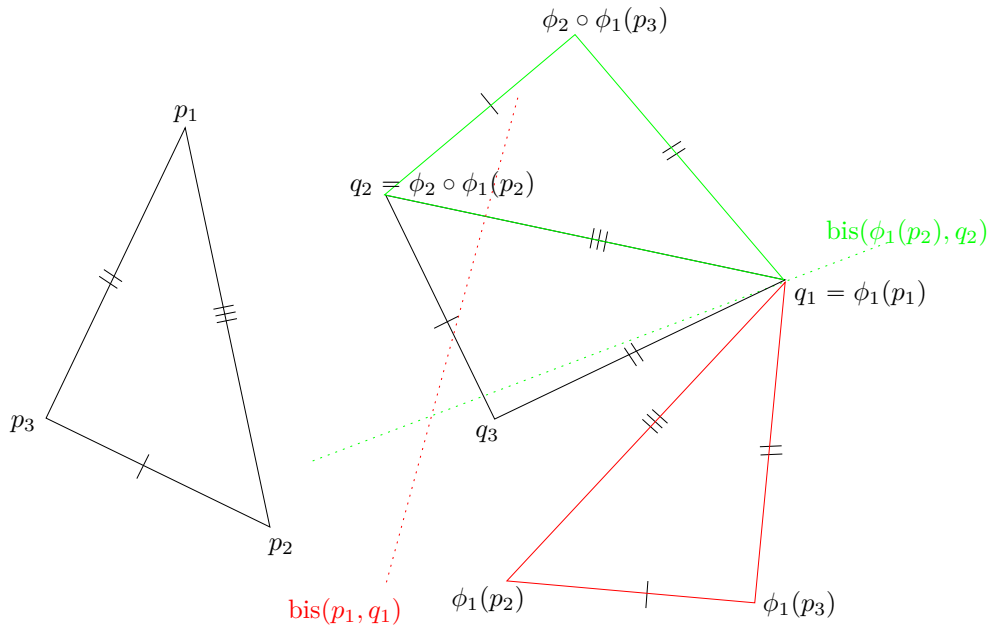

Figure 2.2 —

Proof. We construct the isometry by induction. If $p_1 = q_1$, let ϕ_1 be the identity, otherwise, let ϕ_1 be the reflection in the bisector of p_1 and q_1 . Let $m > 1$ and assume that there is an isometry ϕ_m such that $\phi_m(p_i) = q_i$ for all $i \in \{1, 2, \dots, m\}$, which is the composition of at most m reflections. The mapping ϕ is in $E(n)$ by Proposition 2.10.

Assume that $\phi_m(p_{m+1}) \neq q_{m+1}$. Now, $q_1, \dots, q_m \in \text{bis}(\phi_m(p_{m+1}), q_{m+1})$ because for each $1 \leq i \leq m$, we have

$$d(q_i, \phi_m(p_{m+1})) = d(\phi_m(p_i), \phi_m(p_{m+1})) = d(p_i, p_{m+1}) = d(q_i, q_{m+1}).$$

Thus, the map

$$\phi_{m+1} = r_{\text{bis}(\phi_m(p_{m+1}), q_{m+1})} \circ \phi_m$$

satisfies $\phi_{m+1}(p_i) = q_i$ for all $1 \leq i \leq m+1$. \square

Corollary 2.14. *If T and T' are two triangles in \mathbb{E}^n with equal side lengths, then there is an isometry ϕ of \mathbb{E}^n such that $\phi(T) = T'$.* \square

Corollary 2.15. *Any isometry of \mathbb{E}^n can be represented as the composition of at most $n+1$ reflections.* \square

Proof. Let $\phi \in \text{Isom}(\mathbb{E}^n)$. Proposition 2.13 implies that there is an isometry $\phi_0 \in \text{E}(n)$ such that $\phi_0(\phi(e_i)) = e_i$ for all $1 \leq i \leq n$ and $\phi_0(\phi(0)) = 0$. The set of fixed points of $\phi_0 \circ \phi$ contains the points $0, e_1, \dots, e_n$. In particular, the fixed point set of $\phi_0 \circ \phi$ is not contained in any affine hyperplane. Proposition 2.12(3) implies that $\phi_0 \circ \phi = \text{id}$. Thus, $\phi = \phi_0^{-1}$. \square

Proof of Theorem 2.8. The elements of $\text{E}(n)$ are isometries by Proposition 2.7. The opposite inclusion follows from Corollary 2.15 and Proposition 2.10(2). \square

Proposition 2.16. *The stabiliser in $\text{Isom}(\mathbb{E}^n)$ of any point $x \in \mathbb{E}^n$ is isomorphic to $\text{O}(n)$. An isometry F of \mathbb{E}^n fixes $b \in \mathbb{E}^n$ if and only if there is an orthogonal linear map F_0 such that $F = T_b \circ F_0 \circ T_b^{-1}$.*

Proof. An element of $\text{E}(n)$ fixes the origin if and only if it is an orthogonal linear transformation. Thus the claim holds for 0 . If $b \in \mathbb{E}^n - \{0\}$ and $F \in \text{Stab } b$, then $T_b^{-1} \circ F \circ T_b \in \text{O}(n)$ and for any $A \in \text{O}(n)$, $T_b \circ A \circ T_b^{-1} \in \text{fix } b$ \square

Proposition 2.17. *For each affine k -plane P , there is an isometry $\phi \in \text{Isom}(\mathbb{E}^n)$ such that*

$$\phi(P) = \{x \in \mathbb{E}^n : x^{k+1} = x^{k+2} = \dots = x^n = 0\}.$$

Each affine k -plane of \mathbb{E}^n is isometric with \mathbb{E}^k .

Proof. This is a direct generalisation of Proposition 2.7. The details are left as an exercise. \square

Exercises

2.1. Prove Proposition 2.3.

2.2. Let $x_0 \in \mathbb{E}^n$ and let $u, v \in \mathbb{S}^n$. Let $F: \mathbb{E}^n \rightarrow \mathbb{E}^n$ be an isometry.

- (1) Show that $F \circ j_{x_0, u}$ and $F \circ j_{x_0, v}$ are geodesic lines.
- (2) Show that $F \circ j_{x_0, u}$ and $F \circ j_{x_0, v}$ intersect and that the angle of intersection is the same as for $j_{x_0, u}$ and $j_{x_0, v}$.

2.3. Find an isometry F of \mathbb{E}^2 such that $F(0) = (1, 0)$, $F(1, 0) = (1, 1)$ and $F(0, 1) = (2, 0)$.

2.4. Let $H(0, u)$ be a line in \mathbb{E}^2 that forms an angle $\frac{\phi}{2}$ with the positive x_1 -axis. Let r_u be the reflection in $H(0, u)$.

(1) Compute the matrix of r_u in the standard basis.

(2) Let $u_1, u_2 \in \mathbb{S}^1$. Compute the matrix of $r_{u_2} \circ r_{u_1}$ in the standard basis.

(3) Write the rotation by $\frac{\pi}{2}$ as the composition of two reflections.

2.5. Prove the remaining parts of Proposition 2.10.

2.6. Prove Lemma 2.11.

2.7. Prove Proposition 2.17.

Chapter 3

Spherical geometry

3.1 The sphere

The unit sphere in $(n - 1)$ -dimensional Euclidean space is

$$\mathbb{S}^n = \{x \in \mathbb{E}^{n+1} : \|x\| = 1\}.$$

Let us show that the *angle distance*

$$d_{\mathbb{S}^n}(x, y) = \arccos(x | y) \in [0, \pi] \tag{3.1}$$

is a metric. In order to do this, we will use the analog of the Euclidean law of cosines, but first we have to define the objects that are studied in spherical geometry.

Each 2-dimensional linear subspace $T \subset \mathbb{R}^{n+1}$ intersects \mathbb{S}^n in a *great circle*. If $A \in \mathbb{S}^n$ and $u \in \mathbb{S}^n$ is orthogonal to A ($u \in A^\perp$), then the path $j_{A,u} : \mathbb{R} \rightarrow \mathbb{S}^n$,

$$j_{A,u}(t) = A \cos t + u \sin t,$$

parametrises the great circle $\langle A, u \rangle \cap \mathbb{S}^n$, where $\langle A, u \rangle$ is the linear span of A and u . The vectors A and u are linearly independent, so $\langle A, u \rangle$ is a 2- plane.

Lemma 3.1. *If $d_{\mathbb{S}^n}$ is a metric, then $j_{A,u}$ is a locally geodesic line.*

Proof. Observe that as A and u are unit vectors such that $(A|u) = 0$, we have

$$\begin{aligned} (j_{A,u}(s) | j_{A,u}(t)) &= (A \cos s + u \sin s | A \cos t + u \sin t) \\ &= \|A\|^2 \cos s \cos t + (\cos s \sin t + \sin s \cos t)(A | u) + \sin s \sin t \|u\|^2 \\ &= \cos s \cos t + \sin s \sin t = \cos(s - t). \end{aligned} \tag{3.2}$$

Thus,

$$d(j_{A,u}(s), j_{A,u}(t)) = \arccos(j_{A,u}(s) | j_{A,u}(t)) = \arccos \cos(s - t) = |s - t|,$$

which implies that the restriction of $j_{A,u}$ to any segment of length less than π is an isometric embedding. \square

Note that the computation (3.2) applied with $s = t$ implies that the image of the mapping $j_{A,u}$ is contained in \mathbb{S}^1 .

If $A, B \in \mathbb{S}^n$ such that $B \neq \pm A$, then there is a unique plane that contains both points. Thus, there is unique great circle that contains A and B , in the remaining cases, there are infinitely many such planes. The great circle is parametrised by the map $j_{A,u}$, with

$$u = \frac{B - (B|A)A}{\|B - (B|A)A\|} = \frac{B - (A|B)A}{\sqrt{1 - (A|B)^2}}. \quad (3.3)$$

Now $j(0) = A$ and $j(d(A, B)) = B$.

If $B = -A$, then there are infinitely many great circles through A and B : the map $j_{A,u}$ parametrises a great circle through A and B for any $u \in A^\perp$.

We call the restriction of any $j_{A,u}$ as above to any compact interval $[0, s]$ a *spherical segment*, and u is called the *direction* of $j_{A,u}$. Once we have proved that d is a metric, it is immediate that a spherical segment is a geodesic segment.

Our proof showing that the expression (3.1) defines a metric is based on the spherical law of cosines.

A triangle in \mathbb{S}^n is defined as in the Euclidean case but now the sides of the triangle are the spherical segments connecting the vertices.

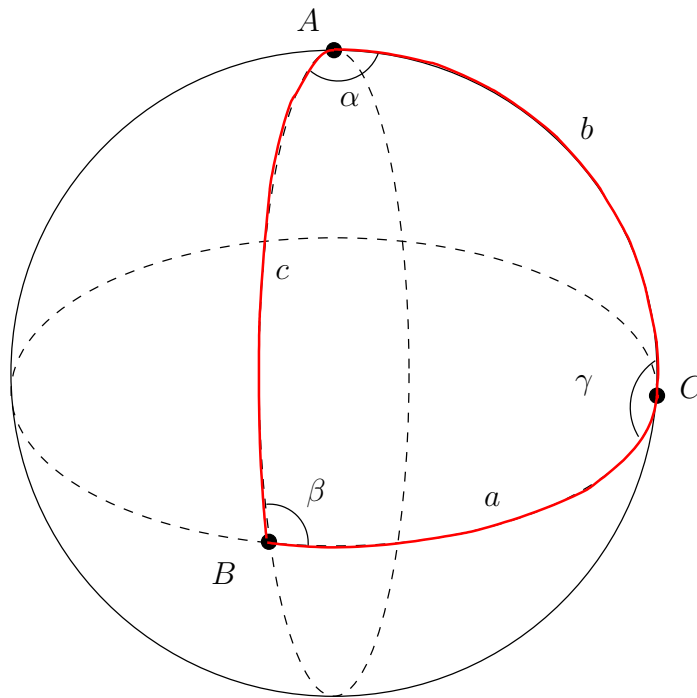

Figure 3.1 — A triangle in \mathbb{S}^2 .

Let $j_{C,u}([0, d(C, A)])$ be the side between C and A , and let $j_{C,v}([0, d(C, B)])$ be the side between C and B . The angle between the sides $j_{C,u}([0, d(C, A)])$ and $j_{C,v}([0, d(C, B)])$ is $\arccos(u|v)$, which is the angle at C between the segments $j_{C,u}([0, d(C, A)])$ and $j_{C,v}([0, d(C, B)])$ in the ambient space \mathbb{E}^{n+1} .

Now we can state and prove

Proposition 3.2 (The spherical law of cosines). *In spherical geometry, the relation*

$$\cos c = \cos a \cos b + \sin a \sin b \cos \gamma$$

holds for any triangle.

Proof. Let u and v be the initial tangent vectors of the spherical segments $j_{C,u}$ from C to A and $j_{C,v}$ from C to B . As u and v are orthogonal to C , we have

$$\begin{aligned} \cos c &= (A | B) = (\cos(b)C + \sin(b)u | \cos(a)C + \sin(a)v) \\ &= \cos(a)\cos(b) + \sin(b)\sin(a)(u | v). \end{aligned} \quad \square$$

Proposition 3.3. *The angle distance is a metric on \mathbb{S}^n .*

Proof. Clearly, the triangle inequality is the only property that needs to be checked to show that the angle metric is a metric. Let $A, B, C \in \mathbb{S}^n$ be three distinct points and use the notation introduced above for triangles. The function

$$\gamma \mapsto f(\gamma) = \cos(a)\cos(b) + \sin(a)\sin(b)\cos(\gamma)$$

is strictly decreasing on the interval $[0, \pi]$, and

$$f(\pi) = \cos(a)\cos(b) - \sin(b)\sin(a) = \cos(a+b).$$

Thus, the law of cosines implies that for all $\gamma \in [0, \pi]$, we have

$$\cos(c) = \cos(a)\cos(b) + \sin(a)\sin(b)\cos(\gamma) \geq \cos(a+b), \quad (3.4)$$

which implies $c \leq a+b$. Thus, the angle distance is a metric. \square

Note that the inequality (3.4) is strict unless $\gamma = \pi$. This also implies that for triangles that are not completely contained in a great circle,

$$c < a+b < 2\pi - c. \quad (3.5)$$

We return to this observation in Section 3.4.

Theorem 3.4. $(\mathbb{S}^n, d_{\mathbb{S}^n})$ is a geodesic metric space. If $d_{\mathbb{S}^n}(A, B) < \pi$, then there is a unique geodesic segment from A to B .

Proof. If $x, y \in \mathbb{S}$ with $y \neq \pm x$, then, by Lemma 3.1, the spherical segment with direction given by the equation (3.3) is a geodesic segment that connects x to y . If the points x and y are antipodal, then it is immediate from the expression of the spherical segment that $j_{x,u}(\pi) = -x$. Thus, in this case there are infinitely many geodesic segments connecting x to y .

If j is a geodesic segment connecting A to B , then any C in $j([0, d(A, B)])$ satisfies

$$d_{\mathbb{S}^n}(A, C) + d_{\mathbb{S}^n}(C, B) = d_{\mathbb{S}^n}(A, B)$$

by definition of a geodesic segment. In the proof of Proposition 3.3, we saw that equality holds in the triangle inequality if and only if $\gamma = \pi$. In this case, all the points A, B and C lie on the same great circle and C is contained in the side connecting A to B . Thus, the spherical segments are the only geodesic segments connecting A and B . If $A \neq \pm B$, then there is exactly one 2-plane containing both points. This proves the second claim. \square

Note that the sphere has no geodesic lines or rays because the diameter of the sphere is π .

3.2 More on cosine and sine laws

The law of cosines implies that a triangle in \mathbb{E}^n or \mathbb{S}^n is uniquely determined up to an isometry of the space, if the lengths of the three sides are known. In Euclidean space the angles are given by

$$\cos \gamma = \frac{a^2 + b^2 - c^2}{2ab}$$

and the corresponding equations for α and β obtained by permuting the sides and angles, and in the sphere we have

$$\cos \gamma = \frac{\cos c - \cos a \cos b}{\sin a \sin b}.$$

In Euclidean space, the three angles of a triangle do not determine the triangle uniquely but in \mathbb{S}^n the angles determine a triangle uniquely. This is the content of

Proposition 3.5 (The second spherical law of cosines). *In spherical geometry, the relation*

$$\cos c = \frac{\cos \alpha \cos \beta + \cos \gamma}{\sin \alpha \sin \beta}$$

holds for any triangle.

Proof. This formula follows from the first law of cosines by manipulation. The first law of cosines implies

$$\sin^2 \gamma = 1 - \cos^2 \gamma = \frac{1 + 2 \cos a \cos b \cos c - (\cos^2 a + \cos^2 b + \cos^2 c)}{\sin^2 a \sin^2 b} = \frac{D}{\sin^2 a \sin^2 b},$$

and D is symmetric in a , b and c . Thus, using the law of cosines, we get

$$\frac{\cos \alpha \cos \beta + \cos \gamma}{\sin \alpha \sin \beta} = \frac{\frac{\cos a - \cos b \cos c}{\sin b \sin c} \frac{\cos b - \cos a \cos c}{\sin a \sin c} + \frac{\cos c - \cos a \cos b}{\sin a \sin b}}{\frac{D}{\sin a \sin b \sin^2 c}} = \cos c.$$

□

Spherical geometry even has its own sine law

Proposition 3.6 (The spherical law of sines). *In spherical geometry, the relation*

$$\frac{\sin a}{\sin \alpha} = \frac{\sin b}{\sin \beta} = \frac{\sin c}{\sin \gamma}$$

holds for any triangle.

Proof. In the proof of the second law of cosines we saw that the first law of cosines implies that

$$\left(\frac{\sin c}{\sin \gamma} \right)^2 = \frac{\sin^2 a \sin^2 b \sin^2 c}{D}.$$

The claim follows because this expression is symmetric in a , b and c . □

3.3 Isometries of \mathbb{S}^n

Proposition 3.7. *The orthogonal group $O(n+1)$ acts transitively by isometries on \mathbb{S}^n . In particular, $\text{Isom}(\mathbb{S}^n)$ acts transitively on \mathbb{S}^n .*

Proof. Let $A \in O(n+1)$ and let $x \in \mathbb{E}^{n+1}$. By definition of orthogonal matrices, we have $\|Ax\|^2 = (Ax | Ax) = \|x\|^2$. Thus, A defines a bijection of the sphere \mathbb{S}^n to itself. Furthermore, for any $x, y \in \mathbb{S}^{n+1}$, again by the definition of orthogonal matrices,

$$\cosh d_{\mathbb{S}^n}(Ax, Ay) = (Ax | Ay) = (x | y) = \cosh d_{\mathbb{S}^n}(x, y),$$

which implies that the above mapping is an isometry.

Transitivity follows from the fact that any element of \mathbb{S}^n can be taken as the first element of an orthogonal basis of \mathbb{E}^n or, equivalently, as the first column of an orthogonal matrix. \square

Theorem 3.8. $\text{Isom}(\mathbb{S}^n) = O(n+1)$

Proof. The claim follows from Proposition 3.7 and Corollary 3.13 and Proposition 3.9 below in the same way as its Euclidean analog, Theorem 2.8, was proven. \square

Let H_0 be a linear hyperplane in \mathbb{E}^n . The intersection $H = H_0 \cap \mathbb{S}^n$ is a *hyperplane* of \mathbb{S}^n .

The *reflection* r_H in H is the restriction of the reflection in H_0 to the sphere: $r_H = r_{H_0}|_{\mathbb{S}^n}$.

Note that each hyperplane of \mathbb{S}^n is isometric with \mathbb{S}^{n-1} and that, by Propositions 2.10(2) and 3.7, the image of $r_{H_0}|_{\mathbb{S}^n}$ is contained in \mathbb{S}^n .

Proposition 3.9. *Let H be an hyperplane in \mathbb{S}^n . Then*

- (1) $r_H \circ r_H$ is the identity.
- (2) $r_H \in O(n+1)$. In particular, r_H is an isometry.
- (3) $d(r_H(x), y) = d(x, y)$ for all $x \in \mathbb{S}^n$ and all $y \in H$.
- (4) The fixed point set of r_H is H .

Proof. (1), (2) and (4) are direct consequences of Proposition 2.10. We leave (3) as an exercise. \square

The *bisector* of two distinct points $p, q \in \mathbb{S}^n$ is

$$\text{bis}(p, q) = \{x \in \mathbb{S}^n : d_{\mathbb{S}^n}(x, p) = d_{\mathbb{S}^n}(x, q)\}.$$

Lemma 3.10. *Let $p, q \in \mathbb{S}^n$, $p \neq q$. Then $\text{bis}(p, q) = (p - q)^\perp \cap \mathbb{S}^n$. In particular, the bisector is a hyperplane, it is the intersection of the Euclidean bisector of p and q with the \mathbb{S}^n .*

Proof. The points $p, q, x \in \mathbb{S}^n$ satisfy $d_{\mathbb{S}^n}(x, p) = d_{\mathbb{S}^n}(x, q)$ if and only if $(p | x) = (q | x)$, which is equivalent with $(p - q | x) = 0$. \square

Proposition 3.11. *Let $x, y \in \mathbb{S}^n$ and let H be a hyperplane of \mathbb{S}^n .*

- (1) *If $r_H(x) = y$ and $x \notin H$, then $H = \text{bis}(x, y)$.*
- (2) *If $p, q \in \mathbb{S}^n$, $p \neq q$, then $r_{\text{bis}(p,q)}(p) = q$.*
- (3) *Let $\phi \in \text{Isom}(\mathbb{S}^n)$, $\phi \neq \text{id}$. If $a \in \mathbb{S}^n$, $\phi(a) \neq a$, then the fixed points of ϕ are contained in $\text{bis}(a, \phi(a))$.*
- (4) *Let $\phi \in \text{Isom}(\mathbb{S}^n)$, $\phi \neq \text{id}$. If H is a hyperplane such that $\phi|_H$ is the identity, then $\phi = r_H$.*

Proof. (1) follows from Proposition 3.9(3).

(2) Using the definitions and the fact that $\frac{p+q}{2}$ is in the Euclidean bisector of p and q , we get

$$r_{\text{bis}(p,q)}(p) = p - 2\left(p - \frac{p+q}{2} \mid p - q\right) \frac{p-q}{\|p-q\|^2} = q.$$

The proofs of (3) and (4) are formally the same as in the Euclidean case. \square

We leave it as an exercise to check that the following result is proved in the same way as their Euclidean counterparts.

Proposition 3.12. *Let $p_1, p_2, \dots, p_k, q_1, q_2, \dots, q_k \in \mathbb{S}^n$ be points that satisfy*

$$d(p_i, p_j) = d(q_i, q_j)$$

for all $i, j \in \{1, 2, \dots, k\}$. Then, there is an isometry $\phi \in \text{Isom}(\mathbb{S}^n)$ such that $\phi(p_i) = q_i$ for all $i \in \{1, 2, \dots, k\}$. \square

Corollary 3.13. *Any isometry of \mathbb{S}^n can be represented as the composition of at most $n + 1$ reflections. \square*

Proposition 3.14. *The stabilizer in $\text{Isom}(\mathbb{S}^n)$ of any point $x \in \mathbb{S}^n$ is isomorphic to $O(n)$.*

Proof. The north pole e_{n+1} is stabilized by the subgroup of $O(n)$ that consists of block diagonal matrices $\text{diag}(A, 1)$, where $A \in O(n)$. Proposition 3.7 implies the claim as in the Euclidean case, see Proposition 2.16. \square

The proof of the following result is similar to that of its Euclidean analog, Proposition 2.17.

Proposition 3.15. *Each k -plane of \mathbb{S}^n is isometric with \mathbb{S}^k . For each k -plane P , there is an isometry $\phi \in \text{Isom}(\mathbb{S}^n)$ such that*

$$\phi(P) = \{x \in \mathbb{S}^n : x^{k+2} = x^{k+3} = \dots = x^{n+1} = 0\}. \quad \square$$

3.4 Triangles in the sphere

In this section, we prove among other results that the sum of the angles of a nondegenerate triangle in \mathbb{S}^2 is greater than π . In order to do this, we introduce the polar triangle of a spherical triangle.

Let $A, B, C \in \mathbb{S}^2$ be points that do not all lie on the same great circle, and let Δ be the triangle with vertices A, B and C . The *polar points* $A^*, B^*, C^* \in \mathbb{S}^2$ of A, B and C are the unique points that satisfy the conditions

$$\begin{aligned} (A^* | B) = 0 &= (A^* | C), & (A^* | A) &> 0 \\ (B^* | C) = 0 &= (B^* | A), & (B^* | B) &> 0 \\ (C^* | A) = 0 &= (C^* | B), & (C^* | C) &> 0. \end{aligned} \tag{3.6}$$

The triangle Δ^* with vertices A^*, B^* and C^* is the *polar triangle* of Δ . Let a^*, b^* and c^* be the side lengths and let α^*, β^* and γ^* be the angles of $(ABC)^*$.

Geometrically, for each vertex of the triangle, the dual vertex is the intersection point of the line orthogonal to the plane that contains the other two vertices, on the same side of the plane as the original vertex.

Lemma 3.16. *The polar points of the vertices of a nondegenerate triangle Δ in \mathbb{S}^2 are linearly independent and $(\Delta^*)^* = \Delta$.*

Proof. Exercise. □

Proposition 3.17. *Let ABC be a triangle in \mathbb{S}^2 such that the vertices do not all lie on the same great circle. Then*

$$a + \alpha^* = b + \beta^* = c + \gamma^* = a^* + \alpha = b^* + \beta = c^* + \gamma = \pi.$$

Proof. The situation is completely symmetric so it suffices to prove $a + \alpha^* = \pi$. Let $u, v \in A^\perp = \langle B^*, C^* \rangle$ be the directions of the edges AB and AC , respectively. Recall that $(u | v) = \cos \alpha$ and $(B^* | C^*) = \cos a^*$.

Now, $u \in \langle A, B \rangle$ implies that $(u | C^*) = 0$ and similarly we have $(v | B^*) = 0$. Furthermore,

$$(u | B^*) = \left(\frac{B - (B | A)A}{\|B - (B | A)A\|} \mid B^* \right) = \frac{(B | B^*)}{\|B - (B | A)A\|} > 0$$

and similarly $(v | C^*) > 0$. Thus, we have either the points u, B^*, C^* and v on the circle $\langle B^*, C^* \rangle$ in this order or in the order B^*, u, v and C^* with the right angles between u and C^* and v and B^* overlapping in both cases. The claim follows easily. □

Lemma 3.18. *The perimeter of a spherical triangle is at most 2π . If the perimeter is 2π , then the vertices are all contained in the same great circle.*

Proof. This follows from the inequality (3.5) and the fact that this inequality is an equality if and only if $\gamma = \pi$. □

Proposition 3.19. *The sum of the angles of a nondegenerate triangle in \mathbb{S}^2 is greater than π .*

Proof. Proposition 3.17 implies that $\alpha + \beta + \gamma + a^* + b^* + c^* = 3\pi$. As $a^* + b^* + c^* < 2\pi$ by Lemma 3.18, we get the claim of Proposition 3.19. □

The following is the spherical analog of Proposition 2.4.

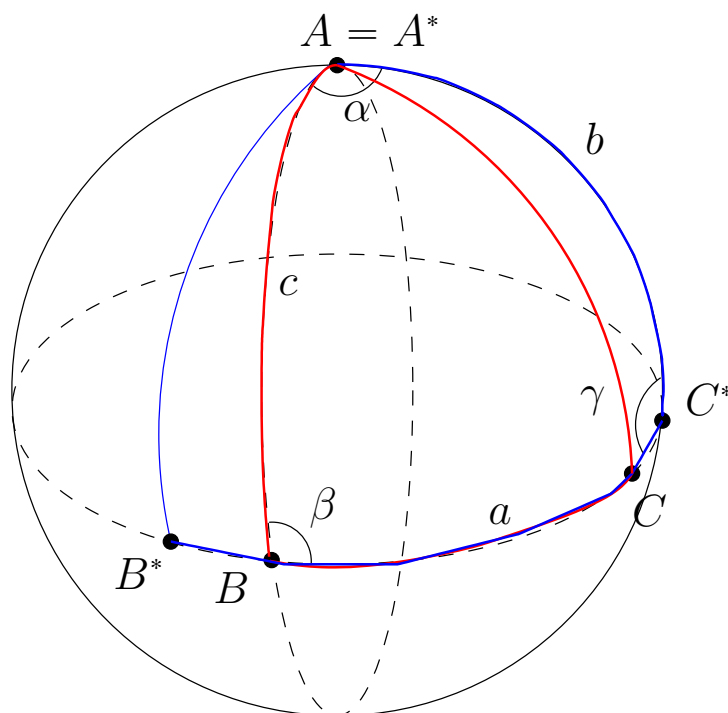

Figure 3.2 — If A is the north pole and B and C are on the equator, then $A = A^*$.

Proposition 3.20. *Let $0 < a, b, c < \pi$. If $a + b > c$, $b + c > a$, $c + a > b$ and $a + b + c < 2\pi$, then there is a triangle in \mathbb{S}^2 with side lengths a , b and c . All such triangles are isometric.*

Proof. We use the law of cosines in the construction: Note that if such a triangle exists, then the angle at C satisfies the cosine law. Therefore, we can compute it if we know that

$$\left| \frac{\cos c - \cos a \cos b}{\sin a \sin b} \right| < 1, \quad (3.7)$$

because then $\frac{\cos c - \cos a \cos b}{\sin a \sin b}$ is in the range of \cos , and we can proceed with the construction. The pair of inequalities $c < a + b < 2\pi - c$ implies

$$\cos c > \cos(a + b) = \cos a \cos b - \sin a \sin b.$$

The inequalities $b + c > a$ and $c + a > b$ give $|a - b| < c$, which implies

$$\cos c < \cos(a - b) = \cos a \cos b + \sin a \sin b.$$

These two inequalities give

$$-\sin a \sin b < \cos c - \cos a \cos b < \sin a \sin b,$$

which implies the inequality (3.7). Now we can place the sides of length a and b starting at C in the correct angle γ . The cosine law implies that the lengths of the side opposite to C is indeed c .

The triangles are isometric by Proposition 3.12 □

3.5 Some elementary Riemannian geometry on \mathbb{S}^2 .

Let $x \in \mathbb{S}^2$. The *latitude* of x is

$$\theta(x) = \frac{\pi}{2} - d_{\mathbb{S}^2}(x, e_3) = \frac{\pi}{2} - \arccos(x | e_3) = \frac{\pi}{2} - \arccos(x_3) \in \left[-\frac{\pi}{2}, \frac{\pi}{2}\right],$$

which is the oriented angle of x from the *equator* $\{x \in \mathbb{S}^2 : x_3 = 0\}$. The *longitude* of $x \in \mathbb{S}^2 - \{\pm e_3\}$ is

$$\phi(x) = \text{sign}(x_2) \arccos\left(\frac{(x_1, x_2, 0) | e_1}{\|(x_1, x_2, 0)\|}\right) = \text{sign}(x_2) \arccos\left(\frac{x_1}{\sqrt{x_1^2 + x_2^2}}\right) \in]-\pi, \pi],$$

where $\text{sign}(t) = \frac{t}{|t|}$ for nonzero t and we set $\text{sign}(0) = 1$.

The longitude is the oriented angle between x and the geodesic segment from the *north pole* e_3 to the *south pole* $-e_3$, called the *0-meridian*.¹ Here we have chosen the value π for the longitude on the *international date line* which is the geodesic segment between the poles that passes through $-e_1$. More generally, the geodesic line between the poles determined by an equation $\phi = c$ is a *meridian* and the circle determined by an equation $\theta = c$ is a *parallel*.

The longitude and latitude of a point define a bijection $L: \mathbb{S}^2 - \{\pm e_3\} \rightarrow]-\pi, \pi] \times]\frac{\pi}{2}, \frac{\pi}{2}[$,

$$L(x) = (\phi(x), \theta(x)).$$

The inverse of this map is given by

$$L^{-1}(\phi, \theta) = (\cos \phi \cos \theta, \sin \phi \cos \theta, \sin \theta).$$

This map is good close to the equator but distances, areas and angles are badly distorted close to the poles.

Let $a \in \mathbb{R} - \{0\}$ and consider the *projection plane* $P_a = \{x \in \mathbb{E}^3 : x_3 = a\}$. For any $x \in \mathbb{S}^2$, let $S_0^a: \mathbb{S}^2 \rightarrow P_a$ be the map

$$S_0^a(x) = (1 - a) \frac{x - e_3}{1 - x_3} + e_3$$

that associates to x the unique point on P_a that lies on the affine line through e_3 and x . The *stereographic projection* $S^a: \mathbb{S}^2 - \{e_3\} \rightarrow \mathbb{E}^2$ is $\text{pr}_3 \circ S_0^a$, where $\text{pr}_3(y) = (y_1, y_2)$ is the orthogonal projection of \mathbb{E}^3 to \mathbb{E}^2 identified with the hyperplane $\mathbb{E}^2 \times \{0\}$. More explicitly,

$$S^a(x) = (1 - a) \left(\frac{x_1}{1 - x_3}, \frac{x_2}{1 - x_3} \right).$$

Most often, one uses $a = 0$, which is the case where the projection plane passes through the origin, or $a = -1$, which is the case where the projection plane is tangent to the sphere at the south pole.

¹the *Greenwich meridian* if we consider the Earth

Length and area

The (*differential geometric*) length of a piecewise continuously differentiable path $\tau: I \rightarrow \mathbb{S}^2$ is

$$\ell(\tau) = \int_I \|\dot{\tau}\|,$$

where $\dot{\tau}(t)$ is the tangent (derivative) vector of the path for each $t \in I$.

Proposition 3.21. *Let $A, B \in \mathbb{S}^2$, $A \neq B$. Let j be a spherical segment that connects A and B . Then $\ell(j) \leq \ell(\tau)$ for all piecewise continuously differentiable paths τ .*

Proof. Using an isometry of \mathbb{S}^2 , we can assume that A and B are contained in the 0-meridian. Using longitude-latitude coordinates, consider the continuous map proj defined by $\text{proj}(\phi, \theta) = (0, \theta)$ whose image is contained in the 0-meridian. Clearly, $\ell(j) \leq \ell(\text{proj} \circ \tau) \leq \ell(\tau)$. \square

In the computation of the length of a path τ , the norm of the tangent vector $\dot{\tau}(t)$ is computed in the tangent plane $\tau(t)^\perp$ at $\tau(t)$. Using the coordinate maps, we get

The inner product of the tangent spaces can be used to define the area of a subset of the sphere. This gives the expressions

$$\text{Area } A = \int_{L(A)} \cos \theta d\theta d\phi$$

in the longitude-latitude coordinates and

$$\text{Area } A = \int_{S^0(A)} \frac{4 dx_1 dx_2}{(1 + \|x\|^2)^2}$$

in the coordinates given by the stereographic projection.

Proposition 3.22. *The area of \mathbb{S}^2 is 4π .*

Let $0 < \alpha < \pi$. The area of the (*spherical*) sector $S_\alpha = \{x \in \mathbb{S}^2 : 0 \leq \phi(x) \leq \alpha\}$ and any of its isometric images is easily seen to be $\frac{\alpha}{2\pi} 4\pi = 2\alpha$.

Proposition 3.23 (Girard). *The area of a triangle with angles α , β and γ is $\alpha + \beta + \gamma - \pi$.*

Proof. Let A , B and C be the vertices of the triangle. The antipodal points $-A$, $-B$ and $-C$ determine a triangle $(-A)(-B)(-C)$ that is isomorphic with ABC . The three great circles $\langle A, B \rangle \cap \mathbb{S}^2$, $\langle B, C \rangle \cap \mathbb{S}^2$ and $\langle C, A \rangle \cap \mathbb{S}^2$ determine six sectors with angles $\alpha, \alpha, \beta, \beta, \gamma, \gamma$ that cover the sphere. In the complement of the great circles, the triangles ABC and $(-A)(-B)(-C)$ are both covered by three sectors, other points are contained in one sector. Thus,

$$4\pi = \text{Area } \mathbb{S}^2 = 2(\text{Area } S_\alpha + \text{Area } S_\beta + \text{Area } S_\gamma) - 4 \text{Area } ABC = 4\alpha - 4 \text{Area } ABC,$$

which gives the claim. \square

Exercises

- 3.1.** Prove Proposition 3.9(3).
- 3.2.** Let H be a hyperplane in \mathbb{S}^n . Prove that $d(r_H(x), y) = d(x, y)$ for all $x \in \mathbb{S}^n$ and $y \in H$.
- 3.3.** Let $\phi \in \text{Isom}(\mathbb{S}^n) - \{\text{id}\}$. Let H be a hyperplane such that $\phi|_H = \text{id}|_H$. Prove that $\phi = r_H$.
- 3.4.** Prove Corollary 3.12 for $n = 2$.
- 3.5.** Prove Corollary 3.13.

Chapter 4

Hyperbolic space

In this chapter, we define hyperbolic space as a submanifold of Minkowski space with a metric that is analogous with the angle metric on the sphere. We will show that hyperbolic space is a uniquely geodesic metric space and that the orthogonal group of the Minkowski bilinear form is the group of isometries of hyperbolic space.

4.1 Minkowski space

Let V and W be real vector spaces. A map $\Phi: V \times W \rightarrow \mathbb{R}$ is a *bilinear form*, if the maps $v \mapsto \Phi(v, w_0)$ and $v \mapsto \Phi(v_0, w)$ are linear for all $w_0 \in W$ and all $v_0 \in V$.

A bilinear form Φ is *nondegenerate* if

- $\Phi(x, y) = 0$ for all $y \in W$ only if $x = 0$, and
- $\Phi(x, y) = 0$ for all $x \in V$ only if $y = 0$.

If $W = V$, then Φ is *symmetric* if $\Phi(x, y) = \Phi(y, x)$ for all $x, y \in V$. It is

- *positive semidefinite* if $\Phi(x, x) \geq 0$ for all $x \in V$,
- *positive definite* if $\Phi(x, x) > 0$ for all $x \in V - \{0\}$,
- *negative (semi)definite* if $-\Phi$ is positive (semi)definite, and
- *indefinite* otherwise.

The *quadratic form* corresponding to a bilinear form $\Phi: V \times V \rightarrow \mathbb{R}$ is the function $q: V \rightarrow \mathbb{R}$, $q(x) = \Phi(x, x)$.

A positive definite symmetric bilinear form is often called an inner product or a scalar product.

If V is a vector space with a symmetric bilinear form Φ , we say that two vectors $u, v \in V$ are *orthogonal* if $\Phi(u, v) = 0$, and this is denoted as usual by $u \perp v$. The

orthogonal complement of $u \in V$ is

$$u^\perp = \{v \in V : u \perp v\}.$$

Let us consider the indefinite nondegenerate symmetric bilinear form $\langle \cdot | \cdot \rangle$ on \mathbb{R}^{n+1} given by

$$\langle x | y \rangle = -x_0y_0 + \sum_{i=1}^n x_iy_i = -x_0y_0 + (\bar{x} | \bar{y}) = x^T J y,$$

where

$$J = J_{1,n} = \text{diag}(-1, 1, \dots, 1)$$

and $x = (x_0, x_1, \dots, x_n) = (x_0, \bar{x})$.

We call $\langle \cdot | \cdot \rangle$ the *Minkowski bilinear form*, and the pair

$$\mathbb{M}^{1,n} = (\mathbb{R}^{n+1}, \langle \cdot | \cdot \rangle)$$

is the $n + 1$ -dimensional *Minkowski space*.

A vector $x \in \mathbb{M}^{1,n}$ is

- *lightlike* or a *null-vector* if $\langle x | x \rangle = 0$,
- *timelike* if $\langle x | x \rangle < 0$, and
- *spacelike* if $\langle x | x \rangle > 0$.

The names for the three different types of vectors in Minkowski space come from Einstein's special theory of relativity, which lives in $\mathbb{M}^{1,3}$. Minkowski space has a number of geometrically significant subsets:

The subset of *null-vectors* is the *light cone*

$$\mathcal{L}^n = \{x \in \mathbb{M}^{1,n} : \langle x | x \rangle = 0\}.$$

The smooth submanifold

$$\mathcal{L}_-^n = \{x \in \mathbb{M}^{1,n} : \langle x | x \rangle = -1\}$$

is a two-sheeted hyperboloid, and its upper sheet is

$$\mathbb{H}^n = \{x \in \mathbb{M}^{1,n} : \langle x | x \rangle = -1, x_0 > 0\}.$$

The smooth submanifold

$$\mathcal{L}_+^n = \{x \in \mathbb{M}^{1,n} : \langle x | x \rangle = 1\}$$

is a one-sheeted hyperboloid.

The following is an important observation on time-like vectors.

Lemma 4.1. *If $u, v \in \mathbb{H}^n$, then $\langle u | v \rangle \leq -1$ with equality only if $u = v$.*

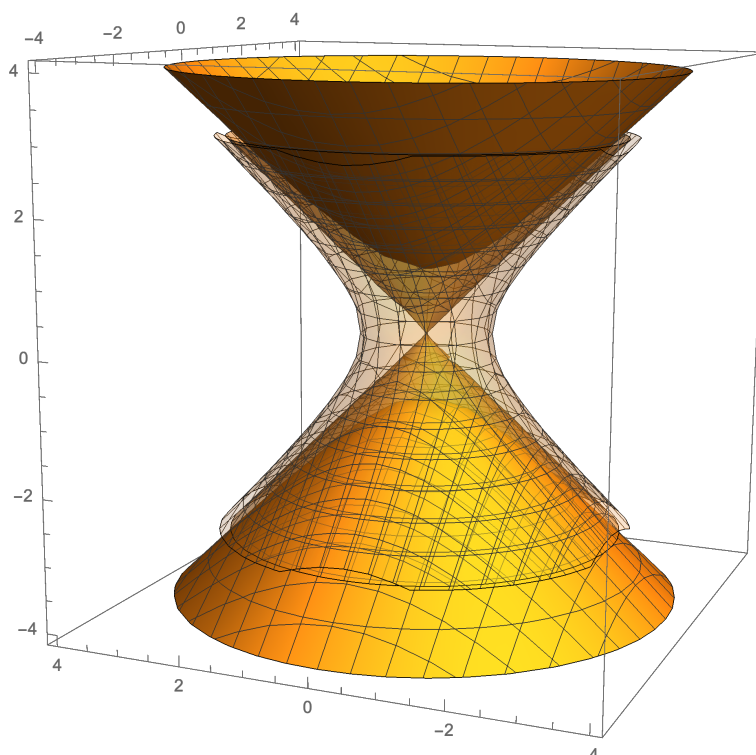

Figure 4.1 — The upper sheet of the two-sheeted hyperboloid with the lightcone and the one-sheeted hyperboloid.

Proof. Using the Cauchy inequality for the Euclidean inner product in \mathbb{R}^n for the first inequality and a simple calculation¹ for the second, we have

$$\begin{aligned} \langle u | v \rangle &= -u_0v_0 + \sum_{i=1}^n u_i v_i \leq -u_0v_0 + \sqrt{\sum_{i=1}^n u_i^2} \sqrt{\sum_{i=1}^n v_i^2} \\ &= -u_0v_0 + \sqrt{u_0^2 - 1} \sqrt{v_0^2 - 1} \leq -1. \end{aligned}$$

Cauchy's inequality is an equality if and only if u and v are parallel, and the final inequality is an equality if and only if $u_0 = v_0$. This implies the claim on equality. \square

4.2 The orthogonal group of Minkowski space

The *orthogonal group* of the Minkowski bilinear form is

$$\begin{aligned} O(1, n) &= \{A \in \text{GL}_{n+1}(\mathbb{R}) : \langle Ax | Ay \rangle = \langle x | y \rangle \text{ for all } x, y \in \mathbb{M}^{1, n}\} \\ &= \{A \in \text{GL}_{n+1}(\mathbb{R}) : {}^T A J_{1, n} A = J_{1, n}\}. \end{aligned}$$

Clearly, the linear action of $O(1, n)$ on $\mathbb{M}^{1, n}$ preserves the light cone and the two-sheeted hyperboloid \mathcal{L}^n .

¹Manipulate the given inequality to remove the square roots etc.

Let $A = (a_0, a_1, \dots, a_n)$ be an $(n+1) \times (n+1)$ -matrix A in terms of its column vectors $a_0, a_1, \dots, a_n \in \mathbb{R}^{n+1}$. If $A \in O(1, n)$, then $a_0 = A(e_0)$ for $e_0 = (1, 0, \dots, 0) \in \mathbb{H}^n$. Thus $A(e_0) \in \mathbb{H}^n$ if and only if $A_{00} > 0$, and therefore the stabiliser in $O(1, n)$ of the upper sheet \mathbb{H}^n is

$$\begin{aligned} O^+(1, n) &= \{A \in O(1, n) : A\mathbb{H}^n = \mathbb{H}^n\} \\ &= \{A \in GL_{n+1}(\mathbb{R}) : A_{00} > 0, \langle Ax | Ay \rangle = \langle x | y \rangle \text{ for all } x, y \in \mathbb{M}^{1,n}\} \\ &= \{A \in GL_{n+1}(\mathbb{R}) : A_{00} > 0, {}^T A J_{1,n} A = J_{1,n}\}. \end{aligned} \quad (4.1)$$

Let us check that the second of the three equalities in (4.1) holds: Let $A \in GL_{n+1}(\mathbb{R})$ with $A_{00} > 0$ and $\langle Ax | Ay \rangle = \langle x | y \rangle$ for all $x, y \in \mathbb{M}^{1,n}$. The first and third properties are equivalent with $A \in O(1, n)$ so it remains to check that $A\mathbb{H}^n = \mathbb{H}^n$. We know that the $Ae_0 \in \mathbb{H}^n$. Linear automorphisms of \mathbb{E}^{n+1} are continuous mappings and the image of a connected set under a continuous map is connected, so \mathbb{H}^n is mapped into \mathbb{H}^n . Similarly, the lower half of the hyperboloid \mathcal{L}^n is mapped into itself. Furthermore, the elements of $GL_{n+1}(\mathbb{R})$ are linear bijections, so the restriction to \mathbb{H}^n is a bijection of \mathbb{H}^n .

A basis $\{v_0, v_1, \dots, v_n\}$ of $\mathbb{M}^{1,n}$ is *orthonormal* if the basis elements are pairwise orthogonal and if $\langle v_0 | v_0 \rangle = -1$ and $\langle v_i | v_i \rangle = 1$ for all $i \in \{1, 2, \dots, n\}$.

The following observation is proved in the same way as its Euclidean analog:

Lemma 4.2. *An $(n+1) \times (n+1)$ -matrix $A = (a_0, a_1, \dots, a_n)$ is in $O(1, n)$ if and only if the vectors a_0, a_1, \dots, a_n form an orthonormal basis of $\mathbb{M}^{1,n}$. Furthermore, $A \in O^+(1, n)$ if and only if $A \in O(1, n)$ and $a_0 \in \mathbb{H}^n$.*

Proof. Exercise. □

Example 4.3. (1) Let $t \in \mathbb{R}$. The matrix

$$L_t = \begin{pmatrix} \cosh t & \sinh t & 0 \\ \sinh t & \cosh t & 0 \\ 0 & 0 & 1 \end{pmatrix} \in O^+(1, 2)$$

stabilizes any affine hyperplane

$$H_c = \{x \in \mathbb{M}^{1,2} : x_2 = c\}.$$

In particular, the path $t \mapsto L_t e_0 = (\cosh t, \sinh t, 0)$ parametrizes the hyperbola

$$\{x \in \mathbb{H}^2 : x_2 = 0\} = \mathbb{H}^2 \cap \{x \in \mathbb{M}^{1,2} : x_2 = 0\}.$$

(2) For any $\theta \in \mathbb{R}$, let $\widehat{R}_\theta = \begin{pmatrix} \cos \theta & -\sin \theta \\ \sin \theta & \cos \theta \end{pmatrix} \in O(2)$, and let

$$R_\theta = \text{diag}(1, \widehat{R}_\theta) = \begin{pmatrix} 1 & 0 & 0 \\ 0 & \widehat{R}_\theta \end{pmatrix} = \begin{pmatrix} 1 & 0 & 0 \\ 0 & \cos \theta & -\sin \theta \\ 0 & \sin \theta & \cos \theta \end{pmatrix} \in O^+(1, 2).$$

This mapping is a Euclidean rotation around the vertical axis by the angle θ . The rotation R_θ stabilizes each affine hyperplane

$$E_r = \{x \in \mathbb{M}^{1,2} : x_0 = r\}.$$

Another important mapping that comes by extension from $O(2)$ is given by the matrix $\text{diag}(1, 1, -1)$, which is a reflection in the hyperplane H_0 defined above.

(3) The above examples can be generalized to higher dimensions:

- L_t is extended as the identity on the last coordinates to $\text{diag}(L_t, I_{n-2}) \in O(1, n)$.
- Any Euclidean orthogonal matrix $A \in O(n)$ gives an isometry $\text{diag}(1, A) \in O^+(1, n)$.

Proposition 4.4. *The group $O^+(1, n)$ acts transitively on \mathbb{H}^n and on the one-sheeted hyperboloid \mathcal{L}_+^n .*

Proof. We use the notation of Example 4.3. If $x \in \mathbb{H}^n$, then $x = (\sqrt{\|\bar{x}\|^2 + 1}, \bar{x})$. There is some $\hat{R}_\theta \in O(n)$ such that $R_\theta \bar{x} = \|\bar{x}\|e_1$, and thus, $R_\theta(x) = (\sqrt{\|\bar{x}\|^2 + 1}, \|\bar{x}\|e_1)$. Furthermore,

$$L_{\text{arsinh } \|\bar{x}\|}e_0 = (\sqrt{\|\bar{x}\|^2 + 1}, \|\bar{x}\|e_1).$$

This implies that \mathbb{H}^n is the $O^+(1, n)$ -orbit of e_0 .

A similar proof shows that \mathcal{L}_+^n is the $O^+(1, n)$ -orbit of e_1 . □

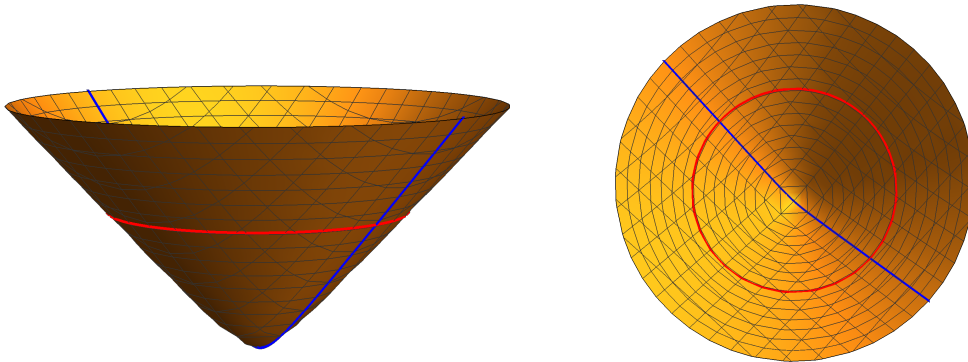

Figure 4.2 — The idea of the proof of Proposition: R_θ moves the point x along the red circle to the blue curve and L_t moves the point along the blue curve to e_1 . The hyperboloid is seen from the side and from the top.

The proof of the following propositions demonstrate the use of a transitive group of transformations:

Proposition 4.5. *The restriction of the Minkowski bilinear form to the orthogonal complement of a timelike vector is positive definite.²*

²Naturally, the orthogonal complement is defined with respect to the Minkowski bilinear form.

Proof. Let $v \in \mathbb{M}^{1,n}$ be a timelike vector. We may assume that $v \in \mathbb{H}^n$. Proposition 4.4 implies the existence of an element $A \in O^+(1, n)$ such that $Av = e_0$. The orthogonal complement of e_0 is the subspace $\{x \in \mathbb{M}^{1,n} : x_0 = 0\}$. The restriction of the Minkowski bilinear form to this subspace is the standard Euclidean inner product. By definition, $\langle A^{-1}u | A^{-1}u \rangle = \langle u | u \rangle > 0$ for all $u \in e_0^\perp$. \square

Proposition 4.6. *For any $a \in \mathbb{H}^n$, the tangent space $T_a\mathbb{H}^n$ of \mathbb{H}^n at a coincides with a^\perp .*

Proof. Let $p \in \mathbb{H}^n$. As the group $O^+(1, n)$ acts transitively on \mathbb{H}^n there is some $A \in O^+(1, n)$ such that $Ae_0 = p$. As in Proposition 4.5, $Ae_0^\perp = p^\perp$. Considering the linear map A as a differentiable mapping of \mathbb{R}^{n+1} to itself, its differential that coincides with A maps the tangent space at e_0 to the tangent spaces at p . Clearly,

$$T_{e_0}\mathbb{H}^n = \{x \in \mathbb{M}^{1,n} : x_0 = 0\} = e_0^\perp$$

and the same holds at p by the observations we just made. \square

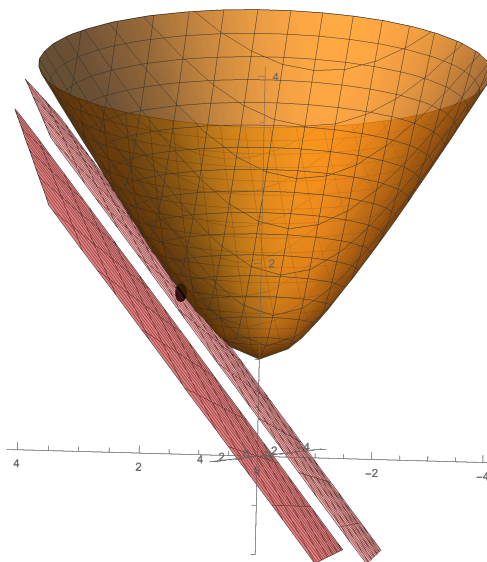

Figure 4.3 — The orthogonal complement p^\perp of a point $p \in \mathbb{H}^2$ coincides with the tangent space $T_p(\mathbb{H}^2)$ as a vector subspace of \mathbb{R}^3 . The figure also shows the affine tangent plane $p + p^\perp$ that is tangent to \mathbb{H}^2 at p . If we consider the standard Euclidean inner product in \mathbb{R}^3 , the tangent plane coincides with the orthogonal complement only at e_0 .

Propositions 4.5 and 4.6 imply that the restriction of the Minkowski bilinear form to each tangent space defines a Riemannian metric.

The *Riemannian metric* of \mathbb{H}^n is $\langle \cdot | \cdot \rangle_{a^\perp}$.

The *angle* $\sphericalangle(u, v)$ of any two vectors $u, v \in T_a\mathbb{H}^n = a^\perp - \{0\}$ is

$$\sphericalangle(u, v) = \arccos(\langle u | v \rangle)$$

The *norm* in a^\perp is

$$|u| = \sqrt{\langle u | u \rangle}$$

for all $u \in a^\perp$.

We will not discuss Riemannian geometry in a formal manner. Hyperbolic space is an important example of a Riemannian manifold, and sometimes³ the definition of the hyperbolic metric is defined as a Riemannian metric. In that approach, hyperbolic metric appears as the path metric of the Riemannian metric.

The *Riemannian length* of a piecewise smooth path $\gamma: [a, b] \rightarrow \mathbb{H}^n$ is

$$\ell(\gamma) = \int_a^b \sqrt{\langle \dot{\gamma}(t) | \dot{\gamma}(t) \rangle} dt.$$

The length metric of the Riemannian metric of \mathbb{H}^n is

$$d_{\text{Riem}}(x, y) = \inf \ell(\gamma),$$

where the infimum is taken over all piecewise smooth paths that connect x to y .

In section 5.3, we will show that the Riemannian approach leads to the same hyperbolic metric as the one we will define in section 4.3. Riemannian geometry also provides a natural concept of volume in hyperbolic space, and we will discuss this in section 5.8.

4.3 Hyperbolic space

In this section, we define a metric on the upper sheet \mathbb{H}^n using the Minkowski bilinear form analogously with the definition of the spherical metric in section 3.1.

The metric space (\mathbb{H}^n, d) , where

$$d(x, y) = \text{arcosh}(-\langle x | y \rangle) \in [0, \infty[,$$

is the *hyperboloid model* of n -dimensional (*real*) *hyperbolic space*. The metric d is the *hyperbolic metric*.

We still need to show that the hyperbolic metric is a metric. The proof follows the same idea that was used to treat the angle metric for the sphere \mathbb{S}^n .

Let $a \in \mathbb{H}^n$, and let $u \in a^\perp$ such that $\langle u | u \rangle = 1$.^a The mapping $j_{a,u}: \mathbb{R} \rightarrow \mathbb{H}^n$,

$$j_{a,u}(t) = a \cosh(t) + u \sinh(t),$$

is the *hyperbolic line* through a in *direction* u . For any $T > 0$, the restriction $j_{a,u}|_{[0,T]}$ is a *hyperbolic segment*.

^aRecall that the restriction of the Minkowski bilinear form to a^\perp is positive definite by Corollary 4.5.

Lemma 4.7. *Let $a \in \mathbb{H}^n$ and $u \in a^\perp$.*

(1) *The image of $j_{a,u}$ is contained in \mathbb{H}^n .*

³See [And] or [Bea]

(2) For all $s, t \in \mathbb{R}$, we have

$$d(j_{a,u}(t), j_{a,u}(s)) = |s - t|. \quad (4.2)$$

(3) $A \circ j_{a,u} = j_{Aa, Au}$ for all $A \in O^+(1, n)$.

Proof. Exercise. □

As in section 3.1 for the sphere, if we show that d is a metric, then $j_{a,u}$ is a geodesic line.

Lemma 4.8. *Let $p, q \in \mathbb{H}^n$ be two distinct points. Let*

$$u = \frac{q + \langle p | q \rangle p}{\sqrt{\langle p | q \rangle^2 - 1}}.$$

The hyperbolic line $j_{p,u}$ satisfies passes through p and q . Furthermore, $j_{p,u}(0) = p$ and $j_{p,u}(\operatorname{arcosh}(-\langle p | q \rangle)) = q$.

Proof. Observe that Lemma 4.1 implies

$$\langle q + \langle p | q \rangle p | q + \langle p | q \rangle p \rangle = \langle p | q \rangle^2 - 1 > 0.$$

Thus, u is a unit tangent vector to the hyperboloid. The fact that $j_{p,u}(0) = p$ is immediate, and the other claim follows by noting that $\sinh(\operatorname{arcosh}(-\langle p | q \rangle)) = \sqrt{\langle p | q \rangle^2 - 1}$. □

Lemma 4.9. *For any $a \in \mathbb{H}^n$ and any $u \in a^\perp$, $j_{a,u}(\mathbb{R}) = \mathbb{H}^n \cap \langle a, u \rangle$. If a 2-plane T intersects \mathbb{H}^n , then $T \cap \mathbb{H}^n$ is the image of a hyperbolic line.*

Proof. Clearly, the image of $j_{a,u}$ is contained in the 2-plane $\langle a, u \rangle$. The fact the image of $j_{a,u}$ coincides with $\langle a, u \rangle \cap \mathbb{H}^n$ follows from the second statement of the Lemma that we prove below.

If $T = \langle e_0, e_1 \rangle$, then $\mathbb{H}^n \cap T$ is a copy of the upper half of the hyperbola

$$\{x \in \mathbb{R}^2 : -x_0^2 - x_1^2 = -1\},$$

and this intersection is parametrized by j_{e_0, e_1} . If $T = \langle e_0, v \rangle$ for any $v \in e_0^\perp$, then there is an element $B \in O(n)$ such that $Be_1 = v$ and, consequently, an element $B' = \operatorname{diag}(1, B) \in O^+(1, n)$ such that $Be_0 = e_0$ and $Be_1 = v$. Thus, $\mathbb{H}^n \cap T = B'(\mathbb{H}^n \cap \langle e_0, e_1 \rangle)$ coincides with the image of the hyperbolic line $B' \circ j_{e_0, e_1} = j_{B'e_0, B'e_1} = j_{e_0, v}$, see Lemma 4.7.

If the plane T does not pass through e_0 but intersects \mathbb{H}^n , then Proposition 4.4 provides an element $A \in O^+(1, n)$ such that $T = A(T_0)$ for some plane T_0 that intersects \mathbb{H}^n at e_0 . We saw above that this intersection is parametrized by a hyperbolic line $j_{e_0, v}$ for some $v \in e_0^\perp$. As above, we see that $\mathbb{H}^n \cap T$ is parametrized by $A \circ j_{e_0, v} = j_{Ae_0, Av}$. □

The fact that the hyperbolic metric is indeed a metric is proved in the same way as Proposition 3.3 in the spherical case. First we prove the law of cosines for triangles in hyperbolic space. As we cannot use a metric yet, we consider triangles whose sides are hyperbolic segments. The angles at the vertices are defined using the Riemannian metric. We use the notation for triangles introduced in section 1.5.

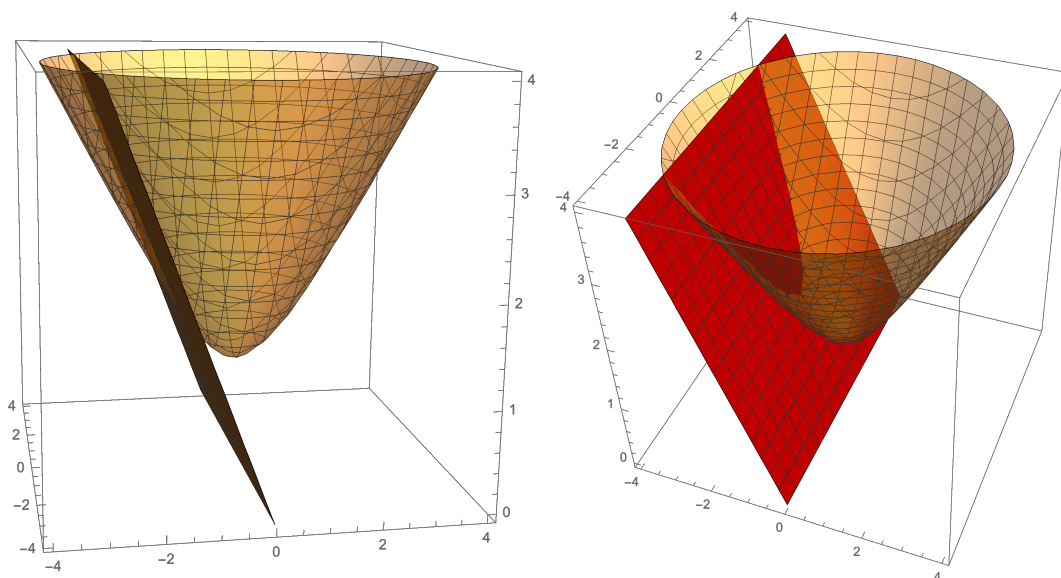

Figure 4.4 — A linear plane that intersects \mathbb{H}^2 seen from two different angles.

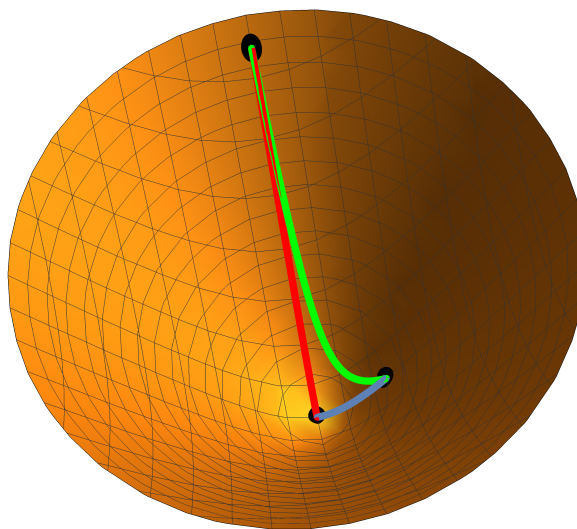

Figure 4.5 — A triangle in \mathbb{H}^2 with a vertex at e_0 .

Proposition 4.10 (The first hyperbolic law of cosines).

$$\cosh c = \cosh a \cosh b - \sinh a \sinh b \cos \gamma .$$

Proof. Let u and v be the initial tangent vectors of the hyperbolic segments from C to A and from C to B . As u and v are orthogonal to C , we have as in the spherical case,

$$\begin{aligned} \cosh c &= -\langle A | B \rangle = -\langle \cosh(b)C + \sinh(b)u | \cosh(a)C + \sinh(a)v \rangle \\ &= \cosh(a) \cosh(b) - \sinh(b) \sinh(a) \langle u | v \rangle . \end{aligned} \quad \square$$

Theorem 4.11. *Hyperbolic space is a uniquely geodesic metric space. Hyperbolic lines are geodesic lines.*

Proof. To show that the hyperbolic metric is a metric, let $A, B, C \in \mathbb{H}^n$. Using the fixed notation for the hyperbolic triangle with vertices A, B and C , consider the strictly increasing function $f: [0, \pi] \rightarrow \mathbb{R}$,

$$f(\gamma) = \cosh a \cosh b - \sinh a \sinh b \cos \gamma,$$

that has a unique maximum at $\gamma = \pi$ with

$$f(\pi) = \cosh a \cosh b + \sinh a \sinh b = \cosh(a + b).$$

The first law of cosines implies that $\cosh c \leq \cosh(a + b)$, which yields the triangle inequality.

Now that we know that hyperbolic space is a metric space, hyperbolic lines are geodesic lines by Lemma 4.7(2). If A and B are distinct points in \mathbb{H}^n , there is a unique 2-plane T through them. Thus, there is exactly one image of a hyperbolic line through these points. Assume that there is a geodesic segment $k: [0, d(A, B)] \rightarrow \mathbb{H}^n$ such that $k(0) = A$, $k(d(A, B)) = B$ and the image of k is not contained in T . Let $C \in k([0, d(A, B)]) - T$ and consider the triangle with vertices A, B and C and sides the unique hyperbolic segments connecting A to B , B to C and C to A . As the function f is strictly increasing, equality is possible in the triangle inequality only when $\gamma = \pi$. This implies that the segments from B to C and from C to A are contained in a hyperbolic line. This hyperbolic line contains A and B and, therefore, the sides from B to C and from C to A are contained in the side from A to B , but this is a contradiction. Thus, \mathbb{H}^n is uniquely geodesic. \square

We will postpone the proof of the following important result until Section 5.3 where the details are simplified by a smart choice of coordinates.

Theorem 4.12. *Hyperbolic metric is the length metric of the Riemannian metric of hyperbolic space.*

4.4 Isometries of \mathbb{H}^n

Proposition 4.13. $O^+(1, n)$ acts transitively by isometries on \mathbb{H}^n . In particular, $\text{Isom}(\mathbb{H}^n)$ acts transitively on \mathbb{H}^n .

Proof. Transitivity of the action was proved in Proposition 4.4 so it remains to show that the elements of $O^+(1, n)$ act as isometries. Let $g \in O^+(1, n)$, and let $x, y \in \mathbb{H}^n$. By the definition of the hyperbolic metric and of $O^+(1, n)$, we have

$$d(g(x), g(y)) = \text{arcosh}(-\langle g(x) | g(y) \rangle) = \text{arcosh}(-\langle x | y \rangle) = d(x, y). \quad \square$$

Example 4.14. (1) Let $t \in \mathbb{R}$. The matrix L_t of Example 4.3 acts on \mathbb{H}^2 as an isometry that preserves the intersection of \mathbb{H}^2 with any affine 2-plane $\{x \in \mathbb{M}^{1,2} : x_2 = c\}$. In particular, it stabilizes the geodesic line

$$\ell = \{x \in \mathbb{H}^3 : x_2 = 0\}.$$

For any point $p = (a, b, 0) \in \ell$, we have

$$d(L_t(p), p) = \operatorname{arcosh}(-\langle L_t p | p \rangle) = \operatorname{arcosh}((-a^2 + b^2) \cosh(t)) = |t|.$$

In chapter 5, we will see that all other points are moved a longer distance than $|t|$.

(2) If $r > 0$, then the set

$$\mathbb{H}^n \cap \{(\cosh r, \bar{x}) : \bar{x} \in \mathbb{R}^n\} = \{(\cosh r, \bar{x}) : \bar{x} \in \mathbb{R}^n, \|\bar{x}\| = \sinh r\}$$

is the sphere of radius r centered at the point $e_0 \in \mathbb{H}^n$. If $A \in O(n)$, the isometry $\operatorname{diag}(1, A) \in O^+(1, n)$ maps each sphere centered at e_0 to itself, and the subgroup $\{\operatorname{diag}(1, A) \in O^+(1, n) : A \in O(n)\} = \operatorname{Stab} e_0 < \operatorname{Isom} \mathbb{H}^n$ acts transitively on each such sphere.

(3) For each $v \in \mathcal{L}^2$ and $c < 0$, the set

$$\{x \in \mathbb{H}^2 : \langle v | x \rangle = c\}$$

is called a *horosphere* based at v . The mapping given by the matrix

$$N_s = \begin{pmatrix} 1 + \frac{s^2}{2} & -\frac{s^2}{2} & s \\ \frac{s^2}{2} & 1 - \frac{s^2}{2} & s \\ s & -s & 1 \end{pmatrix} \in O^+(1, 2)$$

maps each horosphere based at $(1, 1, 0) \in \mathcal{L}^2$ to itself.

(4) Composing some number of the above mappings we obtain further examples of isometries of the hyperbolic plane. For example, if $p \in \mathbb{H}^2$, then there is some $\theta \in \mathbb{R}$ such that $R_\theta(p) \in \ell$. Now, $L_{d(e_0, p)}^{-1}(R_\theta(p)) = L_{-d(e_0, p)}(R_\theta(p)) = e_0$, and for any $\phi \in \mathbb{R}$, the mapping $S = R_{-\theta} \circ L_{d(e_0, p)} \circ R_\phi \circ L_{d(e_0, p)}^{-1} \circ R_\theta$ is an isometry that fixes p and maps each sphere centered at p to itself. The mapping S is conjugate⁴ to R_ϕ in $\operatorname{Isom}(\mathbb{H}^n)$.

The isometries introduced above are classified according to the conic sections they correspond to. The mapping L_t and any of its conjugates in $\operatorname{Isom}(\mathbb{H}^n)$ is called *hyperbolic* because L_t maps each affine plane parallel to the (x_0, x_1) -plane in $\mathbb{M}^{1,2}$ to itself, and these planes intersect the light cone in hyperbola, except for the (x_0, x_1) -plane itself that intersects the lightcone in a pair of lines.

The mapping R_θ and any of its conjugates is called *elliptic* because R_θ preserves all horizontal hyperplanes in $\mathbb{M}^{1,2}$ and their intersections with \mathcal{L}^2 , which are circles centered at points of the 0:th coordinate axis.

The mapping N_s and any of its conjugates is called *parabolic* because it preserves all affine hyperplanes $\{x \in \mathbb{M}^{1,2} : \langle v | x \rangle = c\}$, which intersect \mathcal{L}^2 in a parabola when $c < 0$.

As in the Euclidean and spherical geometries, we will now study a fundamental class of isometries, reflections in a hyperplane.

If T is an $(m + 1)$ -dimensional linear subspace of \mathbb{R}^{n+1} that intersects \mathbb{H}^n , then $T \cap \mathbb{H}^n$ is an m -dimensional *hyperbolic subspace* of \mathbb{H}^n . If $m = n - 1$, then T is a *hyperplane*.

Proposition 4.15. *Let $1 \leq m < n$. Any two hyperbolic m -dimensional subspaces of \mathbb{H}^n can be mapped to each other by isometries of \mathbb{H}^n .*

⁴If G is a group and $g, h \in G$, then the elements g and hgh^{-1} are *conjugate* elements in G .

Proof. Exercise. □

Corollary 4.16. *If $2 \leq k \leq n$, then any k -dimensional hyperbolic subspace of \mathbb{H}^n is isometric to \mathbb{H}^k .*

Proof. The hyperplane $\{x \in \mathbb{H}^n : x_{k+1} = x_{k+2} = \cdots = x_n = 0\}$ is clearly isometric to \mathbb{H}^k . The claim follows from Proposition 4.15. □

Any hyperplane T in $\mathbb{M}^{1,n}$ is of the form $T = u^\perp$ for some $u \in \mathbb{M}^{1,n} - \{0\}$ because the Minkowski bilinear form is nondegenerate. Let $H = u^\perp \cap \mathbb{H}^n$ be a hyperbolic hyperplane. Since H intersects \mathbb{H}^n , it contains a vector v for which $\langle v | v \rangle = -1$. Proposition 4.5 implies that $\langle u | u \rangle > 0$, and after normalising, we may assume that u is a unit vector.

Let $u \in \mathcal{L}_+^n$. The reflection in $H = u^\perp \cap \mathbb{H}^n$ is the map

$$r_H(x) = x - 2\langle x | u \rangle u. \quad (4.3)$$

Example 4.17. If $u_0 = 0$, then $\langle x | u \rangle = (x | u)$ for all $x \in \mathbb{M}^{1,n}$. This implies that the reflection in u^\perp coincides with the Euclidean reflection in the hyperplane u^\perp that contains e_0 .

The proofs of the basic properties of reflections are natural modifications of those in the spherical case. Note that the expression (4.3) defines a mapping in Minkowski space, fixing the hyperplane u^\perp . The reflection in hyperbolic space is, in fact, the restriction of a reflection of Minkowski space.

Proposition 4.18. *Let H be a hyperbolic hyperplane. Then*

- (0) r_H maps \mathbb{H}^n into itself.
- (1) $r_H \circ r_H$ is the identity.
- (2) $r_H \in O^+(1, n)$.
- (3) $d(r_H(x), y) = d(x, y)$ for all $x \in \mathbb{H}^n$ and all $y \in H$.
- (4) The fixed point set of r_H is H .

Proof. (0) Let $x \in \mathbb{H}^n$. Using bilinearity and symmetry of the Minkowski form and the fact that u is a unit vector, we get

$$\begin{aligned} \langle r_H(x) | r_H(x) \rangle &= \langle x - 2\langle x | u \rangle u | x - 2\langle x | u \rangle u \rangle \\ &= \langle x | x \rangle - 2\langle x | u \rangle \langle x | u \rangle - 2\langle x | u \rangle \langle u | x \rangle + 4\langle x | u \rangle \langle x | u \rangle \langle u | u \rangle \\ &= \langle x | x \rangle = -1. \end{aligned}$$

Thus, $r_H(x) \in \mathcal{L}_-^n$. Furthermore, for any $v \in H$,

$$r_H(v) = v - 2\langle v | u \rangle u = v,$$

so there are points in \mathbb{H}^n which are mapped to \mathbb{H}^n . Since r_H is continuous and preserves the Minkowski form, $r_H(\mathbb{H}^n) \subset \mathbb{H}^n$.

- (1) This easy computation is left as an exercise.
- (2) Clearly, r_H is a linear mapping, and it is a bijection by (1). As in (0), we get

$$\langle r_H(x) | r_H(y) \rangle = \langle x - 2\langle x | u \rangle u | y - 2\langle y | u \rangle u \rangle = \langle x | y \rangle.$$

Thus, $r_H \in O(1, n)$. Claim (0) gives $r_H \in O^+(1, n)$.

(3) For any $x \in \mathbb{H}^n$ and all $y \in H$, we have

$$\langle r_H(x) | y \rangle = \langle x - 2\langle x | u \rangle u | y \rangle = \langle x | y \rangle - 2\langle x | u \rangle \langle u | y \rangle = \langle x | y \rangle,$$

where the final equality follows from the assumption $u \in H^\perp$.

(4) This follows immediately from (3) by taking $x = y \in H$. \square

The *bisector* of two distinct points p and q in \mathbb{H}^n is the hyperplane

$$\text{bis}(p, q) = \{x \in \mathbb{H}^n : d(x, p) = d(x, q)\}.$$

Lemma 4.19. *If $p, q \in \mathbb{H}^n$, $p \neq q$, then $\text{bis}(p, q) = (p - q)^\perp \cap \mathbb{H}^n$.*

Proof. Exercise. \square

Proposition 4.20. (1) *For any $p, q \in \mathbb{H}^n$, the bisector $\text{bis}(p, q)$ is a hyperbolic hyperplane.*

(2) *If H is a hyperplane in \mathbb{H}^n and $x, y \in \mathbb{H}^n - H$ with $r_H(x) = y$, then $H = \text{bis}(x, y)$.*

(3) *If $p, q \in \mathbb{H}^n$, $p \neq q$, then $r_{\text{bis}(p, q)}(p) = q$.*

(4) *Let $\phi \in \text{Isom}(\mathbb{H}^n)$, $\phi \neq \text{id}$. If $a \in \mathbb{H}^n$ with $\phi(a) \neq a$, then the fixed points of ϕ are contained in $\text{bis}(a, \phi(a))$.*

(5) *Let $\phi \in \text{Isom}(\mathbb{H}^n)$, $\phi \neq \text{id}$. If H is a hyperplane such that $\phi|_H$ is the identity, then $\phi = r_H$.*

Proof. (1) Lemma 4.1 implies that

$$\langle p - q | p - q \rangle = -2 - 2\langle p | q \rangle > 0.$$

Let $\lambda > 0$ and $u \in \mathcal{L}_+^n$ such that $p - q = \lambda u$. Obviously, $(p - q)^\perp = u^\perp$. The second part of Proposition 4.4 implies that there is an element $A \in O^+(1, n)$ such that $Au = e_1$. The orthogonal complement of e_1 is the hyperplane $\{x \in \mathbb{M}^{1, n} : x_1 = 0\}$ that contains e_0 . The claim follows as A maps \mathbb{H}^n to itself and $(Au)^\perp = A(u^\perp)$.

(2) follows from Proposition 4.18(3).

(3) Using the computation from (1) above, we have

$$2\langle p | p - q \rangle = 2(\langle p | p \rangle - \langle p | q \rangle) = -2 - 2\langle p | q \rangle = |p - q|^2.$$

Thus,

$$r_{\text{bis}(p, q)}(p) = p - 2\langle p | p - q \rangle \frac{p - q}{|p - q|^2} = q.$$

(4) If $\phi(b) = b$, then $d(a, b) = d(\phi(a), \phi(b)) = d(\phi(a), b)$, so that $b \in \text{bis}(a, \phi(a))$.

(5) is an instructive exercise. \square

Proposition 4.21. *Any two reflections in hyperbolic hyperplanes of \mathbb{H}^n are conjugate in $\text{Isom } \mathbb{H}^n$.*

Proof. Exercise. \square

Next, we prove that all isometries of hyperbolic space are restrictions to \mathbb{H}^n of linear automorphisms of $\mathbb{M}^{1,n}$:

Theorem 4.22. $\text{Isom}(\mathbb{H}^n) = \text{O}^+(1, n)$.

The idea of the proof is to show that each isometry of \mathbb{H}^n is the composition of reflections in hyperbolic hyperplanes. Again, the proof follows the same ideas as in the Euclidean and spherical cases.

Proposition 4.23. *Let $p_1, p_2, \dots, p_k, q_1, q_2, \dots, q_k \in \mathbb{H}^n$ be points that satisfy*

$$d(p_i, p_j) = d(q_i, q_j)$$

for all $i, j \in \{1, 2, \dots, k\}$. Then, there is an isometry $\phi \in \text{Isom}(\mathbb{H}^n)$ such that $\phi(p_i) = q_i$ for all $i \in \{1, 2, \dots, k\}$. Furthermore, the isometry ϕ is the composition of at most k reflections in hyperplanes.

Proof. The proof is formally exactly the same as that of Proposition 2.13. □

Note that Proposition 4.23 implies that if T and T' are two triangles in \mathbb{H}^n with equal sides, then there is an isometry ϕ of \mathbb{H}^n such that $\phi(T) = T'$.

Proof of Theorem 4.22. Let $\phi \in \text{Isom}(\mathbb{H}^n)$. Let $\{a_0, a_1, \dots, a_n\}$ be a set of points in \mathbb{H}^n which is not contained in any proper hyperbolic subspace. This is achieved by choosing them so that they generate $\mathbb{M}^{1,n}$ as a vector space. Proposition 4.23 implies that there is an isometry $\phi_0 \in \text{O}^+(1, n)$ such that $\phi_0(\phi(a_i)) = a_i$ for all $0 \leq i \leq n$. Since the set of fixed points of $\phi_0 \circ \phi$ contains the points a_0, a_1, \dots, a_n , the fixed point set of $\phi_0 \circ \phi$ is not contained in a proper hyperbolic subspace. Proposition 4.20(4) implies that $\phi_0 \circ \phi$ is the identity map. Thus, $\phi = \phi_0^{-1}$. In particular, $\phi \in \text{O}^+(1, n)$, which is all we needed to show. □

Corollary 4.24. *Any isometry of \mathbb{H}^n can be represented as the composition of at most $n + 1$ reflections.* □

Proposition 4.25. *The stabilizer of any point $x \in \mathbb{H}^n$ is isomorphic to $\text{O}(n)$.*

Proof. Again, we follow the proof of the spherical case. The details are left as an exercise. □

4.5 Triangles in \mathbb{H}^n

The law of cosines implies that a triangle in \mathbb{E}^n , \mathbb{S}^n or \mathbb{H}^n is uniquely determined up to an isometry of the space, if the lengths of the three sides are known. In Euclidean space, the three angles of a triangle do not determine the triangle uniquely. In \mathbb{S}^n and \mathbb{H}^n the angles determine a triangle uniquely. For \mathbb{H}^n , this is the content of

Proposition 4.26 (The second hyperbolic law of cosines).

$$\cosh c = \frac{\cos \alpha \cos \beta + \cos \gamma}{\sin \alpha \sin \beta}.$$

Proof. This formula follows from the first law of cosines by a lengthy manipulation analogous to the proof of Proposition 3.5. See for example [Bea, p. 148–150]. \square

The second law of cosines and Proposition 4.23 imply that if T and T' are two triangles in \mathbb{H}^n with equal sides, then there is an isometry ϕ of \mathbb{H}^n such that $\phi(T) = T'$.

Proposition 4.27 (The hyperbolic law of sines).

$$\frac{\sinh a}{\sin \alpha} = \frac{\sinh b}{\sin \beta} = \frac{\sinh c}{\sin \gamma}.$$

Proof. The first law of cosines implies that

$$\left(\frac{\sinh c}{\sin \gamma}\right)^2 = \frac{\sinh^2 a \sinh^2 b \sinh^2 c}{2 \cosh a \cosh b \cosh c - \cosh^2 a - \cosh^2 b - \cosh^2 c + 1}.$$

The claim follows because this expression is symmetric in a , b and c . \square

The following two results on triangles will be useful later.

Proposition 4.28. *For any $0 < a, b, c$ for which $a + b > c$, $b + c > a$ and $c + a > b$, there is a triangle with side lengths a , b and c . Any two such triangles are isometric.*

Proof. The proof is analogous with that of Proposition 3.20 without the upper bound on the lengths. We use the hyperbolic law of cosines in the construction. If a triangle with the asserted properties exists, then the angle at C satisfies the cosine law. Therefore, we can compute what this angle needs to be if we know that

$$\left| \frac{\cosh a \cosh b - \cosh c}{\sinh a \sinh b} \right| < 1. \quad (4.4)$$

The inequality $c < a + b$ implies

$$\cosh c < \cosh(a + b) = \cosh a \cosh b + \sinh a \sinh b,$$

which gives

$$-1 < \frac{\cosh a \cosh b - \cosh c}{\sinh a \sinh b}.$$

The inequalities $b + c > a$ and $c + a > b$ give $|a - b| < c$, which implies

$$\cosh c > \cosh(a - b) = \cosh a \cosh b + \sinh a \sinh b,$$

and we get

$$\frac{\cosh a \cosh b - \cosh c}{\sinh a \sinh b} < 1.$$

Now we can place the sides of length a and b starting at C in the correct angle γ . The cosine law implies that the distance of the endpoints points A and B of these segments is c . There geodesic arc from A to B is therefore the side opposite to C of the desired length c .

The triangles are isometric by Proposition 4.23. \square

Proposition 4.29. *Any triangle in \mathbb{H}^n is contained in an isometrically embedded copy of \mathbb{H}^2 in \mathbb{H}^n .*

Proof. Any three points in the hyperboloid model \mathbb{H}^n are contained in the intersection of \mathbb{H}^n with a 3-dimensional linear subspace of $\mathbb{M}^{1,n}$, which is an isometrically embedded copy of the hyperbolic plane. The geodesic arc through any two of these points is contained in the same hyperbolic 2-plane by Lemma 4.9. \square

Using the hyperbolic law of cosines and the Taylor polynomials of hyperbolic functions at 0, $\cosh t = 1 + \frac{t^2}{2} + o(t^2)$ and $\sinh t = t + o(t)$, we see that if the sides of a triangle in hyperbolic space are short, then the sides satisfy the Euclidean law of cosines up to a small error.

Exercises

- 4.1. Prove Lemma 4.2.
- 4.2. Prove Lemma 4.7.
- 4.3. Prove Proposition 4.15.
- 4.4. Prove Lemma 4.19.
- 4.5. Prove Proposition 4.20(5).
- 4.6. Prove Proposition 4.21.⁵
- 4.7. Prove Proposition 4.23.
- 4.8. Prove Proposition 4.25.⁶

⁵Use Proposition 4.15.

⁶Assume that we know $\text{Isom } \mathbb{H}^n = O^+(1, n)$ and use transitivity.

Chapter 5

Models of hyperbolic space

The hyperboloid model of hyperbolic space introduced in chapter 4 model is used in many arithmetical applications and the closely related projective model has important generalizations to complex and quaternionic hyperbolic spaces.

In this chapter, we consider a number of other models for hyperbolic space. Hyperbolic space of dimension n is the class of all metric spaces isometric with the hyperboloid model (\mathbb{H}^n, d) , and we can use any model that is best suited for the geometric problem at hand. After this section we will often talk about the “upper halfplane model of \mathbb{H}^2 ” etc.

The underlying set of the Klein model and the Poincaré model is the unit ball in Euclidean space. Therefore, we introduce a special notation for this set:

\mathbb{B}^n is the unit ball in \mathbb{E}^n .

In sections 5.2, 5.3 and 5.5, we use the geometric properties of inversions in spheres. We refer to Appendix A for details on inversions.

5.1 Klein’s model

Each line in $\mathbb{M}^{1,n}$ through the origin which intersects the hyperboloid model \mathbb{H}^n , intersects it in exactly one point, and it also intersects the embedded copy $\{1\} \times \mathbb{B}^n$ in $\mathbb{M}^{1,n}$ of \mathbb{B}^n in exactly one point. This correspondence determines a bijection $K: \mathbb{B}^n \rightarrow \mathbb{H}^n$, which has the explicit expression

$$K(x) = \frac{(1, x)}{\sqrt{1 - \|x\|^2}}.$$

The map K becomes an isometry when we define a metric on \mathbb{B}^n by setting

$$d_K(x, y) = d(K(x), K(y)) = \operatorname{arcosh} \frac{1 - (x|y)}{\sqrt{1 - \|x\|^2} \sqrt{1 - \|y\|^2}}.$$

The metric space (\mathbb{B}^n, d_K) is the *Klein model* of n -dimensional hyperbolic space.

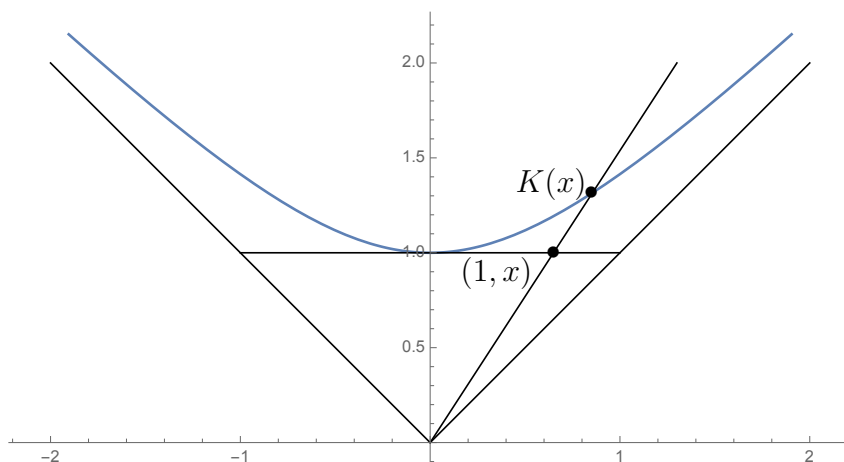

Figure 5.1 — The map K used in the construction of the Klein model.

Proposition 5.1. *The images of geodesic lines of the Klein model are Euclidean open segments connecting two points in the Euclidean unit sphere.*

Proof. A geodesic line in \mathbb{H}^n is the intersection of \mathbb{H}^n with a 2-plane in $\mathbb{M}^{1,n}$. The intersection of this plane with $\mathbb{B}^n \times \{1\}$ is the preimage under K of the geodesic line. \square

Proposition 5.1 implies that for any two distinct points $a, b \in \mathbb{S}^{n-1} = \partial\mathbb{B}^n$, there is a unique image of a geodesic line $]a, b[$ in the Klein model. We call $]a, b[$ the *geodesic line with endpoints a and b in the Klein model of \mathbb{H}^n* . Note that if $\gamma: \mathbb{R} \rightarrow \mathbb{H}^n$ is a geodesic line and $T \in \mathbb{R}$, then the mapping $t \mapsto \gamma(t - T)$ defined on \mathbb{R} is a geodesic line such that $\gamma(\mathbb{R}) = \gamma_T(\mathbb{R})$.

If $x_0 \in \mathbb{B}^n$ and $b \in \partial\mathbb{B}^n$, there is a unique geodesic ray $\rho_{x_0, b}: [0, \infty[\rightarrow \mathbb{B}^n$ in the Klein model of \mathbb{H}^n such that $\rho_{x_0, b}(0) = x_0$ and such that the Euclidean closure of the image $\rho_{x_0, b}([0, \infty[) = [x_0, b[$ is the Euclidean closed segment $[x_0, b]$.

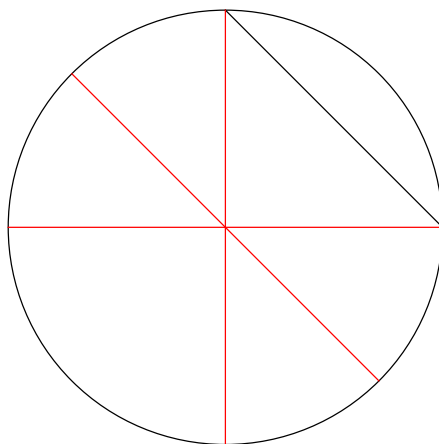

Figure 5.2 — Three red lines through the origin that are parallel in the Klein model with the line whose endpoints are $(0, 1)$ and $(1, 0)$.

Recall that in Euclidean plane geometry, two (geodesic) lines are {em parallel if they do not intersect. The *parallel axiom* states that through any point P in the Euclidean plane that is not contained in a line L , there is exactly one line that is parallel with L . It is easy to see using the Klein model that the parallel axiom does not hold in \mathbb{H}^2 , see Figure 5.2

5.2 Poincaré's ball model

Each affine line that passes through the point $(-1, 0) \in \mathbb{R} \times \mathbb{R}^n = \mathbb{M}^{1,n}$ which intersects \mathbb{H}^n , intersects it in exactly one point, and it also intersects the n -dimensional ball $\{0\} \times \mathbb{B}^n$ embedded in $\mathbb{M}^{1,n}$ in exactly one point. This correspondence determines a bijection $P: \mathbb{B}^n \rightarrow \mathbb{H}^n$,

$$P(x) = \frac{(1 + \|x\|^2, 2x)}{1 - \|x\|^2}.$$

This expression is found by computing for any $x \in \mathbb{B}^n$ that the point $y_t = (0, x) + t(1, x)$ on the line through the points $(0, x)$ and $(-1, 0)$ of $\mathbb{R} \times \mathbb{R}^n = \mathbb{M}^{1,n}$ is in \mathbb{H}^n if and only if $t = \frac{1 + \|x\|^2}{1 - \|x\|^2}$.

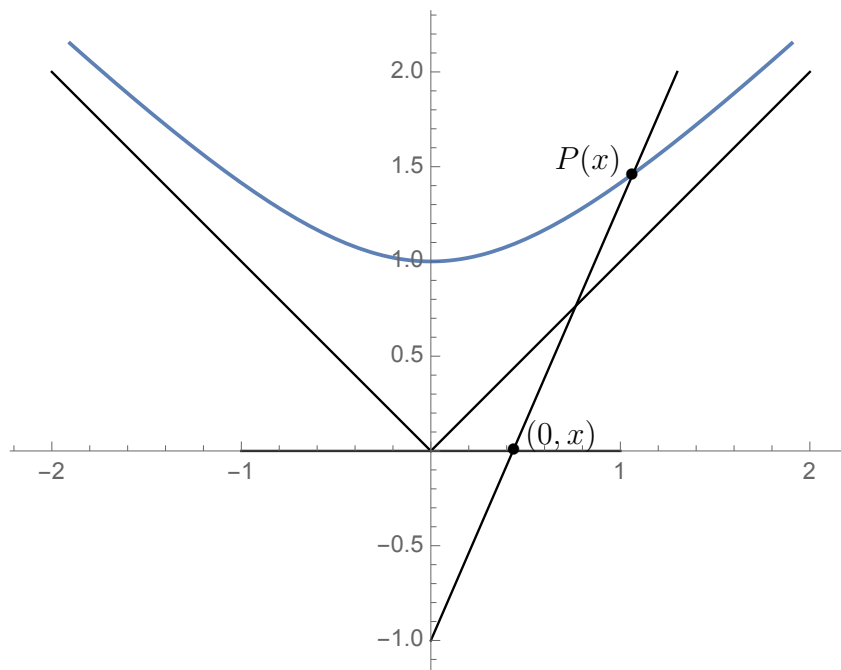

Figure 5.3 — The map P used in the construction of the Poincaré model.

The map P becomes an isometry when we define a metric on \mathbb{B}^n by setting

$$d_P(x, y) = d(P(x), P(y)) = \operatorname{arcosh} \left(1 + 2 \frac{\|x - y\|^2}{(1 - \|x\|^2)(1 - \|y\|^2)} \right).$$

The metric space (\mathbb{B}^n, d_P) is the *Poincaré model* of n -dimensional hyperbolic space.

Lemma 5.2. *The hyperbolic ball of radius $r > 0$ centered at 0 in the Poincaré model coincides with the Euclidean ball of radius $\tanh \frac{r}{2}$ centered at 0. The Euclidean ball of radius $0 < R < 1$ centered at 0 coincides with the hyperbolic ball of radius $\log \frac{1+R}{1-R}$ centered at 0 in the Poincaré model.*

Proof. If $x \in \mathbb{B}^n$, we have

$$d_P(x, 0) = \operatorname{arcosh} \left(1 + 2 \frac{\|x\|^2}{1 - \|x\|^2} \right) = \log \frac{1 + \|x\|}{1 - \|x\|}.$$

Both claims follow from this equation. \square

Proposition 5.3. *The images of geodesic lines of the Poincaré model are the intersections of the Euclidean unit ball with Euclidean circles and lines that are orthogonal to the unit sphere.*

Proof. The map $h = K^{-1} \circ P$ is an isometry between the Poincaré and Klein models. A computation¹ shows that

$$h(x) = \frac{2x}{1 + \|x\|^2}.$$

The inversion $\iota_{(-1,0),2}$ in the sphere centered at $(-1, 0) \in \mathbb{E}^1 \times \mathbb{E}^n$ of radius $\sqrt{2}$ maps $\{0\} \times \mathbb{E}^n \cup \{\infty\}$ to \mathbb{S}^n . It maps $\{0\} \times \mathbb{B}^n \cup \{\infty\}$ to the upper hemisphere of \mathbb{S}^n , fixing $\{0\} \times \mathbb{S}^{n-1}$. In coordinates,

$$\iota_{(-1,0),2}(x) = \left(\frac{1 - \|x\|^2}{1 + \|x\|^2}, \frac{2x}{1 + \|x\|^2} \right),$$

so that if $\operatorname{pr}: \mathbb{E}^{n+1} = \mathbb{E}^1 \times \mathbb{E}^n \rightarrow \mathbb{E}^n$ is the Euclidean orthogonal projection on the second component of the product, we have

$$h = \operatorname{pr} \circ \iota_{(-1,0),2}.$$

The inversion $\iota_{(-1,0),2}$ maps any circle in $\{0\} \times \mathbb{B}^n$ orthogonal to $\{0\} \times \mathbb{S}^{n-1}$ to a circle on the unit sphere in \mathbb{E}^{n+1} orthogonal to $\{0\} \times \mathbb{S}^{n-1}$. These circles are orthogonal to $\{0\} \times \mathbb{E}^n$, and they are exactly the intersections of the unit sphere with 2-planes parallel to the x_0 -axis, and thus, pr maps them to the geodesic lines of the Klein model. As h is an isometry, the result follows. \square

Note that the mapping h from the Klein model to the Poincaré model is the restriction of a homeomorphism of the Euclidean closure of \mathbb{B}^n to itself. This extended mapping is the identity in the boundary of \mathbb{B}^n . Analogously with the case of the Klein model, Proposition 5.3 implies that for any two distinct points $a, b \in \mathbb{S}^{n-1} = \partial\mathbb{B}^n$, there is geodesic line $]a, b[$ in the Poincaré model that we call the *geodesic line with endpoints a and b in the Poincaré model of \mathbb{H}^n* . If $x_0 \in \mathbb{B}^n$ and $b \in \partial\mathbb{B}^n$, there is a unique geodesic ray $\rho_{x_0,b}: [0, \infty[\rightarrow \mathbb{B}^n$ in the Poincaré model of \mathbb{H}^n such that $\rho_{x_0,b}(0) = x_0$ and such that the Euclidean closure of the image $\rho_{x_0,b}([0, \infty[) = [x_0, b[$ is a closed Euclidean segment or a closed circular segment with one endpoint at b .

¹This can be done by observing that h is a radial map and then solving the equation

$$\frac{(1, y)}{\sqrt{1 - y^2}} = \left(\frac{1 + x^2}{1 - x^2}, \frac{2x}{1 - x^2} \right)$$

with $0 \leq x, y < 1$.

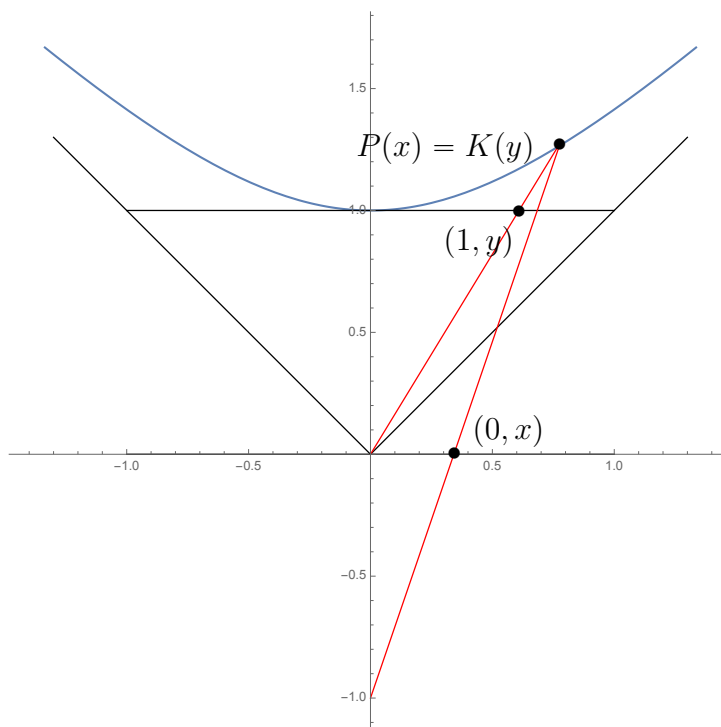

Figure 5.4 — The construction of the map h from the Poincaré model to the Klein model.

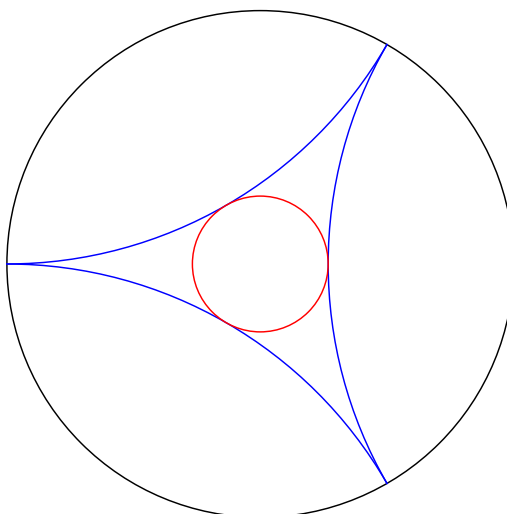

Figure 5.5 — Some geodesic lines and a ball in the Poincaré disk model of \mathbb{H}^2 .

Proposition 5.4. *The Riemannian metric of the ball model is $\frac{4(\cdot|\cdot)}{(1-\|x\|^2)^2}$.*

Proof. For all tangent vector $u \in T_x B(0, 1)$, we have

$$DP(x)u = \left(\frac{4(x|u)}{(1-\|x\|^2)^2}, \frac{2u}{1-\|x\|^2} + \frac{4(x|u)x}{(1-\|x\|^2)^2} \right) \in \mathbb{M}^{1,n}.$$

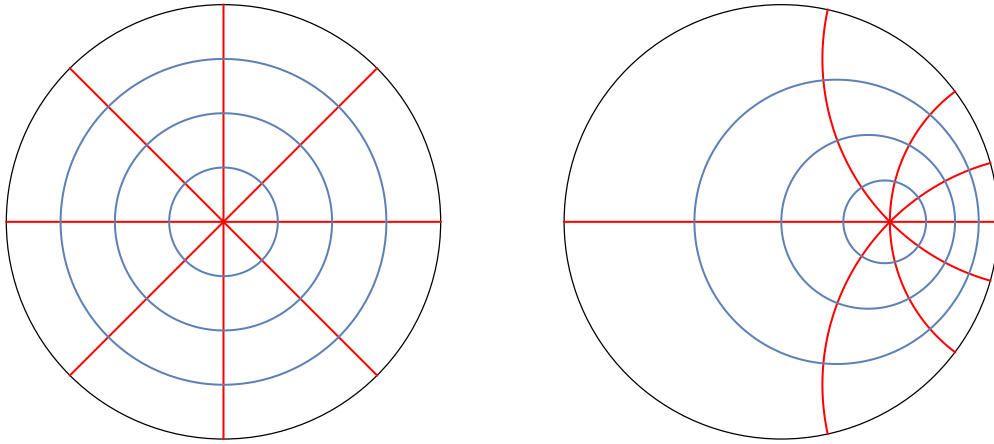

Figure 5.6 — Geodesic rays starting at 0 and at $(\frac{1}{2}, 0)$ with circles centered at the same points in the Poincaré disk model of \mathbb{H}^2 .

Using this, for u, v in $T_x\mathbb{B}^n$, we compute

$$\begin{aligned} \langle DP(x)u \mid DP(x)v \rangle &= -\frac{16(x \mid u)(x \mid v)}{(1 - \|x\|^2)^4} + \frac{4(u \mid v)}{(1 - \|x\|^2)^2} + \frac{16(x \mid u)(x \mid v)}{(1 - \|x\|^2)^3} + \frac{16(x \mid u)(x \mid v)\|x\|^2}{(1 - \|x\|^2)^4} \\ &= \frac{4(u \mid v)}{(1 - \|x\|^2)^2}. \end{aligned} \quad \square$$

Proposition 5.4 implies that the angles between tangent vectors of paths in the Poincaré model are the same as the angles measured in the ambient Euclidean space.

5.3 The upper halfspace model

Let

$$\mathbb{R}^n_+ = \{x \in \mathbb{R}^n : x_n > 0\}$$

be the n -dimensional *upper halfspace*. Let $\iota_{-e_n, 2}$ be the inversion in the sphere of center $-e_n \in \mathbb{E}^n$ of radius $\sqrt{2}$. The map

$$F = \iota_{-e_n, 2}|_{\mathbb{B}^n} : \mathbb{B}^n \rightarrow \mathbb{R}^n_+ \quad (5.1)$$

is a bijection, which becomes an isometry if we use the metric

$$d_{\mathbb{R}^n_+}(x, y) = d_P(F^{-1}(x), F^{-1}(y)) = \operatorname{arcosh} \left(1 + \frac{\|x - y\|^2}{2x_n y_n} \right) \quad (5.2)$$

in \mathbb{R}^n_+ .

The metric space $(\mathbb{R}^n_+, d_{\mathbb{R}^n_+})$ is the *upper halfspace model* of n -dimensional hyperbolic space.

Example 5.5. An elementary computation shows that if $x = (a, x_n)$ and $y = (a, y_n)$ for any $a \in \mathbb{R}^{n-1}$, then

$$d_{\mathbb{R}^n_+}(x, y) = \left| \log \frac{x_n}{y_n} \right|.$$

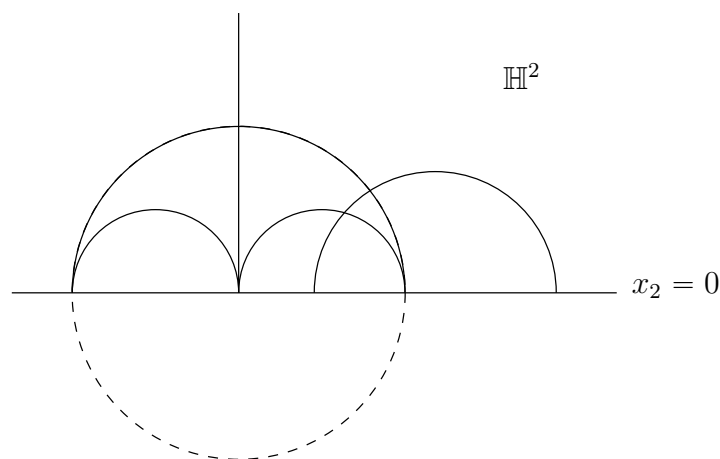

Figure 5.7 — Some geodesic lines in the upper halfplane model of \mathbb{H}^2 .

It is very common to identify the upper halfplane model of \mathbb{H}^2 with the upper halfplane in \mathbb{C} , and we will often do this, as in the following Example 5.6(2) below.

Example 5.6. (1) Let $n \geq 3$. The subspace $\{x \in \mathbb{R}_+^n : x_2 = \cdots = x_{n-1} = 0\}$ with the metric induced from the upper halfspace model is an isometrically embedded copy of \mathbb{H}^2 in the upper halfspace model of \mathbb{H}^n .

(2) Let $0 < \phi < \pi$. Then the distance of the points i and $e^{i\phi}$ in the upper halfplane model is

$$d_{\mathbb{R}_+^2}(i, e^{i\phi}) = \operatorname{arcosh} \left(1 + \frac{\cos^2 \phi + (1 - \sin \phi)^2}{2 \sin \phi} \right) = \operatorname{arcosh} \frac{1}{\sin \phi}.$$

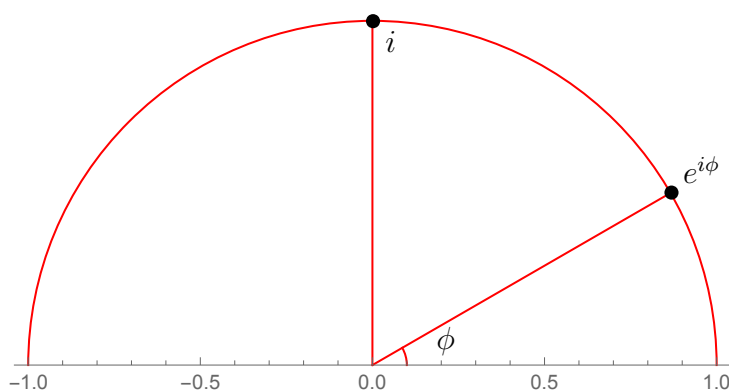

Figure 5.8 —

Proposition 5.7. *The images of the geodesic lines of the upper halfspace model are the intersections of the upper halfspace with Euclidean circles and lines that are orthogonal to $\mathbb{E}^{n-1} \times \{0\}$.*

Proof. The inversion used in the definition of the upper halfspace model maps lines and circles to lines or circles and preserves angles. The claim follows from Proposition 5.3. \square

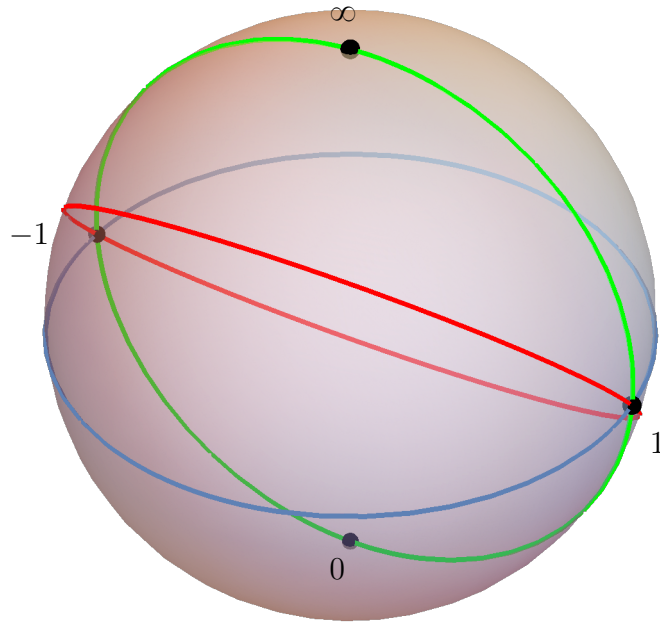

Figure 5.9 — The mapping F corresponds to the reflection in the red circle when $\widehat{\mathbb{E}}^2$ is identified with \mathbb{S}^2 by the stereographic projection. See section 3.3 and Appendix A.

Geodesic lines in the upper halfspace model are images under F of geodesic lines of the Poincaré model. If one of the endpoints of a geodesic line in the Poincaré model is $-e_n$, then F maps this geodesic line to a halfline orthogonal to $\mathbb{E}^{n-1} \times \{0\}$ at one end, and the other endpoint is mapped to $\infty \in \widehat{\mathbb{E}}^n$.

Proposition 5.7 implies that for any two distinct points $a, b \in \mathbb{E}^{n-1} \times \{0\} \cup \{\infty\}$, there is geodesic line $]a, b[$ in the upper halfspace model that we call the *geodesic line with endpoints a and b in the upper halfspace model of \mathbb{H}^n* .

We have seen that the unit sphere in the Klein and Poincaré ball models and the set $\mathbb{E}^{n-1} \times \{0\} \cup \{\infty\} \subset \widehat{\mathbb{E}}^n$ in the upper halfspace model have a geometric meaning, and that there is a natural homeomorphism between these sets. In chapter 8, we will see that these sets appear naturally as a geometrically defined *boundary at infinity* of \mathbb{H}^n , and we will use the notation $\partial_\infty \mathbb{H}^n$ for this set from now on.

In practical applications, it is good to remember that a circle is perpendicular to $\mathbb{E} \times \{0\} \subset \mathbb{E}^2$ if and only if its center is in $\mathbb{E} \times \{0\}$. In higher dimensions, this is no longer true.

The following lemma records the expressions of the geodesics in the upper halfspace.

Lemma 5.8. *Let $x \in \mathbb{R}^{n-1}$ and $y > 0$. The mapping $\gamma_{x,y}: \mathbb{R} \rightarrow \mathbb{R}_+^n$,*

$$\gamma_{x,y}(t) = (x, ye^t)$$

is a geodesic line in the upper halfspace model of \mathbb{H}^n such that $\gamma_{x,y}(0) = (x, y)$. For any isometry g of the upper halfspace model, the mapping $g \circ \gamma_{x,y}$ is a geodesic line.

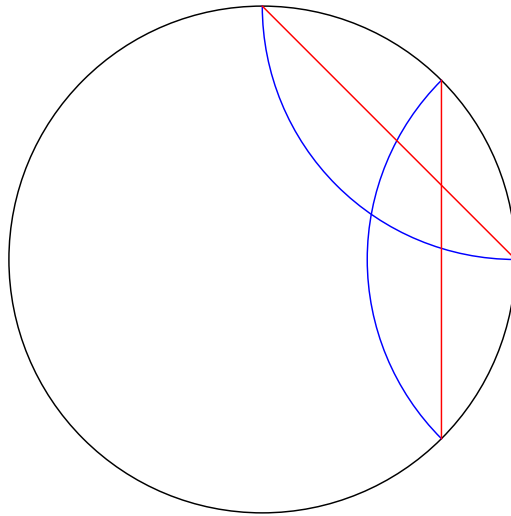

Figure 5.10 — The blue geodesic lines of the Poincaré model in this figure are the images of the red geodesic lines of the Klein model. The angles at the points of intersection are the same in hyperbolic plane but the angle in the ambient Euclidean space of the red lines is not the same as that of the blue circular segments.

Proof. Apply Example 5.5. □

Proposition 5.9. *The Riemannian metric of the upper halfspace model is $\frac{(\cdot|\cdot)}{x_n^2}$.*

Proof. The proof is similar to that of Proposition 5.4, using (the inverse of) the map F defined in equation (5.1) to transfer the Riemannian metric from the ball to the upper halfspace. □

Proposition 5.9 implies that the angles between tangent vectors of paths in the upper halfspace model are the same as the angles measured in the ambient Euclidean space. The Klein model does not have this useful property. This is illustrated in Figure 5.10

Proof of Theorem 4.12. We will use the upper halfspace model to prove the result. Both quantities are invariant under isometries of hyperbolic space. Therefore, it is sufficient to show that the geodesic segment $[(0, 1), (0, T)]$ is the Riemannian geodesic segment from $(0, 1)$ to $(0, T)$ for any $T > 0$.

Let $\phi: [0, 1] \rightarrow \mathbb{H}^n$ be a piecewise smooth path such that $\phi(0) = (0, 1)$ and $\phi(1) = (0, T)$.² Let $p: \mathbb{H}^n \rightarrow [0, 1]$,

$$p(x, s) = (0, s)$$

for all $x \in \mathbb{R}^{n-1}$ and $s > 0$, be the *horospherical projection* to the geodesic line $]0, \infty[$ that contains the points $(0, 1)$ to $(0, T)$. Note that $Dp(x, s)u = u_n$ for all $(x, s) \in \mathbb{H}^n$ and all $u \in \mathbb{R}^n$. This implies that $|(p \circ \phi)(\tau)| \leq |\dot{\phi}(\tau)|$ for all $\tau \in [0, 1]$.³ This gives the inequality

²We can assume that all paths are defined on $[0, 1]$ because smooth reparametrization does not change the Riemannian length of a path, see for example [Pet, Section 5.3].

³ \dot{f} is the notation we use for the derivative vector of a path f .

we want:

$$\ell(\phi) = \int_0^1 \frac{|\dot{\phi}(\tau)|}{\phi_n(\tau)} d\tau \geq \int_0^1 \frac{|(p \circ \phi)(\tau)|}{(p \circ \phi)_n(\tau)} d\tau \geq \log(p \circ \phi(1)) = \log T = d((0, 1), (0, T)).$$

Note that the second inequality is strict if the mapping $t \mapsto \phi_n(t)$ is not monotonous.

To complete the proof, note that if $\gamma_{0,1}$ is the geodesic line of Lemma 5.8, $\gamma_{0,1}(0) = (0, 1)$, $\gamma(\log T) = (0, T)$ and

$$\ell(\gamma|_{[0, \log T]}) = \int_0^{\log T} \frac{|\dot{\gamma}(t)|}{\gamma_n(t)} dt = \int_0^{\log T} \frac{ye^t}{ye^t} dt = \log T. \quad \square$$

5.4 Triangles in \mathbb{H}^n (part 2)

The Poincaré model and the upper halfspace model are very useful in many proofs for example because the angle between two tangent vectors in these models is the same as the Euclidean angle. We use this property to prove the following facts on triangles in hyperbolic space.

Proposition 5.10. (1) *The sum of the angles of a nondegenerate triangle in hyperbolic space is strictly less than π .*

(2) *For any $0 < \alpha, \beta, \gamma < \pi$ for which $\alpha + \beta + \gamma < \pi$, there is a triangle with angles α, β and γ . Any two such triangles are isometric.*

Proof. By Proposition 4.29, it suffices to consider the hyperbolic plane.

(1) Let T be a triangle with vertices A, B and C . We may assume that one of the vertices A is the origin in the Poincaré disk model. Thus, two sides of the triangle are contained in two radii of the ball and the third one is contained in a circle which is orthogonal to the boundary of \mathbb{B}^n . Consider the Euclidean triangle with the same vertices as T . The angles β and γ are strictly smaller than the corresponding angles in the Euclidean triangle. This implies the result as the angles of an Euclidean triangle sum to π .

(2) Let us consider the upper halfplane model of \mathbb{H}^2 . Let $0 < r < 1$. At most one of the angles can be greater than or equal to $\frac{\pi}{2}$, and we may assume that $0 < \alpha, \beta < \frac{\pi}{2}$. The geodesic line contained in the Euclidean circle with center $\cos \alpha > 0$ and radius 1 intersects the geodesic line $]0, \infty[$ at an angle α , and the geodesic line contained in the Euclidean circle with center $-r \cos \beta < 0$ and radius r intersects $]0, \infty[$ at an angle β . When $\frac{1 - \cos \alpha}{1 + \cos \beta} < r < \frac{\sin \alpha}{\sin \beta}$, there are subsegments of these three geodesic lines that make up a triangle where the third angle grows from 0 to $\pi - \alpha - \beta$. \square

5.5 Isometries of the upper halfspace model

In the upper halfspace model, it is often convenient to move a geodesic line by an isometry such that the endpoints of the geodesic in the model are 0 and ∞ . The following results on isometries allow to do that and a bit more. We illustrate the utility of the transitivity properties of the group of isometries in Proposition 5.14 and its corollaries, and in Lemma 5.20.

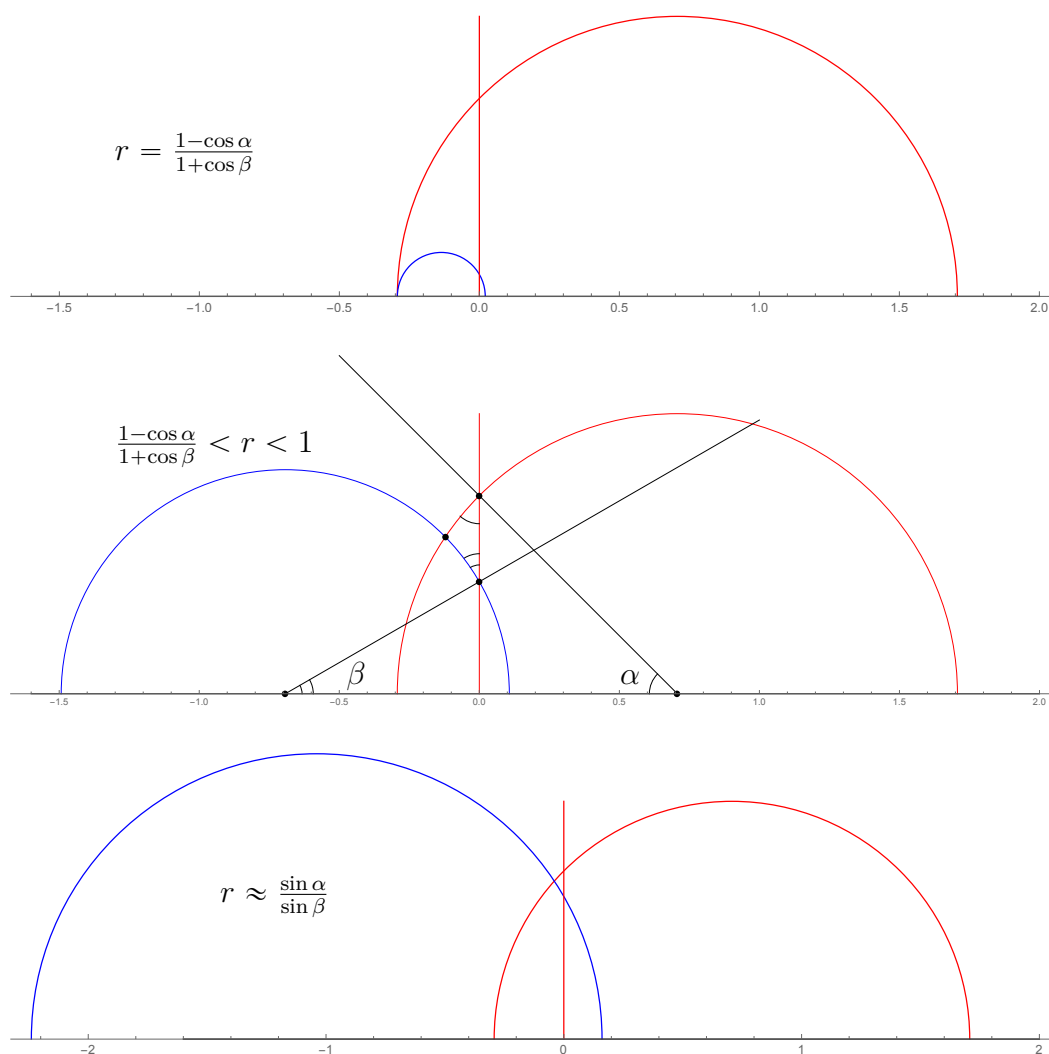

Figure 5.11 — The idea of the proof of Proposition 5.10. Here $\alpha = \frac{\pi}{4}$ and $\beta = \frac{\pi}{6}$.

Let $b \in \mathbb{R}^{n-1} \times \{0\} \subset \mathbb{R}^n$. The mapping $T_b: \mathbb{R}_+^n \rightarrow \mathbb{R}_+^n$,

$$T_b(x) = x + b,$$

is a *horizontal translation* by b .

Let $\lambda > 0$. The mapping $L_\lambda: \mathbb{R}_+^n \rightarrow \mathbb{R}_+^n$,

$$L_\lambda(x) = \lambda x,$$

is a *dilation by factor* λ .

Let $Q_0 \in O(n-1)$ and let us use the notation $x = (\bar{x}, x_n)$. The mapping $Q: \mathbb{R}_+^n \rightarrow \mathbb{R}_+^n$,

$$Q(\bar{x}, x_n) = (Q_0(\bar{x}), x_n),$$

is an *orthogonal mapping around the geodesic line* $]0, \infty[$.

Lemma 5.11. *Let $a, b \in \mathbb{R}^{n-1} \times \{0\} \subset \mathbb{R}^n$ and let $\lambda > 0$.*

$$(1) T_b \circ \iota_{a,r^2} \circ T_{-b} = \iota_{a+b,r^2}.$$

$$(2) L_\lambda \circ \iota_{0,r^2} \circ L_{\frac{1}{\lambda}} = \iota_{0,(\lambda r)^2}.$$

Proof. Exercise. □

Proposition 5.12. *The maps*

- T_b for any $b \in \mathbb{R}^{n-1} \times \{0\} \subset \mathbb{R}^n$,
- ι_{a,r^2} , for any $a \in \mathbb{R}^{n-1} \times \{0\} \subset \mathbb{R}^n$ and any $r > 0$,
- L_λ for any $\lambda > 0$, and
- Q for any $Q_0 \in O(n-1)$

are isometries of the upper halfspace model.

Proof. Let us consider the inversion in the Euclidean unit sphere. It preserves all affine rays from a , so it preserves the upper halfspace. To prove that its restriction to \mathbb{H}^n is an isometry, equation (5.2) implies that it is enough to show that the expression $\frac{\|x-y\|^2}{x_n y_n}$ is invariant under the inversion. Let us compute:

$$\frac{\iota_{0,1}(x) - \iota_{0,1}(y)}{r^2} = \frac{x}{\|x\|^2} - \frac{y}{\|y\|^2} = \frac{x\|y\|^2 - y\|x\|^2}{\|x\|^2\|y\|^2},$$

which gives

$$\frac{\|\iota_{0,1}(x) - \iota_{0,1}(y)\|^2}{\iota_{0,1}(x)_n \iota_{0,1}(y)_n} = \frac{\frac{\|x\|^2\|y\|^4 - 2(x|y)\|x\|^2\|y\|^2 + \|x\|^4\|y\|^2}{\|x\|^4\|y\|^4}}{\frac{x_n y_n}{\|x\|^2\|y\|^2}} = \frac{\|x - y\|^2}{x_n y_n}.$$

The rest is left as an exercise. □

Corollary 5.13. *The subgroup of $\text{Isom}(\mathbb{H}^n)$ generated by dilations fixing 0 and horizontal translations acts transitively on the upper halfspace model of \mathbb{H}^n .*

Proof. If x is in the upper half plane,

$$T_{-(x_1, x_2, \dots, x_{n-1}, 0)}(x) = (0, \dots, x_n) = L_{x_n} e_n.$$

Thus,

$$x = T_{(x_1, x_2, \dots, x_{n-1}, 0)} \circ L_{x_n} e_n. \quad \square$$

We will now apply the transitivity of the action of the group of isometries and of suitable subgroups to geometric and topological questions.

Proposition 5.14. *Balls in the upper halfspace model and in the Poincaré ball model are Euclidean balls in the Euclidean space that contains the model.*

Proof. By Lemma 5.2, balls centered at the origin of the Poincaré ball model are Euclidean balls. The inversion that maps the ball model to the upper halfspace model is an isometry, and on the other hand it preserves generalized spheres. Thus, the images of the balls centered at the origin are hyperbolic and Euclidean balls. The hyperbolic center of these balls can be mapped to any other point in \mathbb{H}^n by one of the isometries of Corollary 5.13. These mappings preserve spheres, which implies that all balls in the upper halfspace model are Euclidean balls. The rest of the claim follows by one more application of the inversion that maps the ball model to the upper halfspace model. \square

Corollary 5.15. *Hyperbolic space \mathbb{H}^n is homeomorphic with the open unit ball of \mathbb{E}^n .*

Proof. The identity map from the Poincaré model to the $\mathbb{B}^n \subset \mathbb{E}^n$ with the induced metric is a homeomorphism by Proposition 5.14. \square

Corollary 5.16. *Hyperbolic space \mathbb{H}^n is a proper metric space.* \square

Proposition 5.17. *Let x_1, x_2, x_3 and y_1, y_2, y_3 be two triples of distinct points in the boundary at infinity of \mathbb{H}^n . There is an isometry of \mathbb{H}^n which is the restriction of a homeomorphism g of $\mathbb{H}^n \cup \partial_\infty \mathbb{H}^n$ to itself such that $g(x_i) = y_i$ for all $i \in \{1, 2, 3\}$.*

Proof. Let us consider the question in the upper halfspace model. The mappings given in Proposition 5.12 are clearly continuous mappings of $\widehat{\mathbb{E}}^n$ to itself.

It suffices to show that we can use a combination of these isometries to map x_1, x_2, x_3 to $\infty, 0, (1, 0, \dots, 0)$. If all points x_1, x_2, x_3 are finite, map x_1 by a translation T_{-x_1} to 0 and then by the inversion ι to ∞ . Relabel $\iota \circ T_{-x_1}(x_2)$ and $\iota \circ T_{-x_1}(x_3)$ to x_2 and x_3 . Map x_2 to 0 by a translation. This map keeps ∞ fixed. Map x_3 (again relabeled) to the unit sphere by a dilation and then to $(1, 0, \dots, 0)$ by the extension of an orthogonal map of \mathbb{E}^{n-1} . These two maps fix ∞ and 0. \square

Proposition 5.18. *Let $x, y \in \mathbb{H}^n$ and $a, b \in \partial_\infty \mathbb{H}^n$. There is an isometry of \mathbb{H}^n which is the restriction of a homeomorphism g of $\mathbb{H}^n \cup \partial_\infty \mathbb{H}^n$ to itself such that $g(x) = y$ and $g(a) = b$.*

Proof. Exercise. \square

In the proofs of Propositions 5.17 and 5.18, we used explicit isomorphisms of the upper half plane model that are restrictions of homeomorphic self-maps of $\mathbb{H}^n \cup \partial_\infty \mathbb{H}^n$. In fact, there is a result that generalizes this observation to all isometries:

Theorem 5.19. *The isometries of \mathbb{H}^n are restrictions of homeomorphic self-maps of $\mathbb{H}^n \cup \partial_\infty \mathbb{H}^n$.*

Proof. We could prove this by showing that all reflections in hyperplanes have this property, and then using the fact that reflections generate $\text{Isom } \mathbb{H}^n$. The proof relies on showing that in the upper halfplane model, reflections in hyperbolic hyperplanes are either conjugates of the map Q of Proposition 5.12 with Q_0 a hyperplane reflection in \mathbb{E}^{n-1} , or inversions.

Instead, we postpone the proof until Chapter 8, where we prove a more general result by a different method. \square

For any $r > 0$, the r -neighbourhood of any nonempty subset $A \subset \mathbb{H}^n$ is

$$\mathcal{N}_r(A) = \{x \in \mathbb{H}^n : d(x, A) < r\}.$$

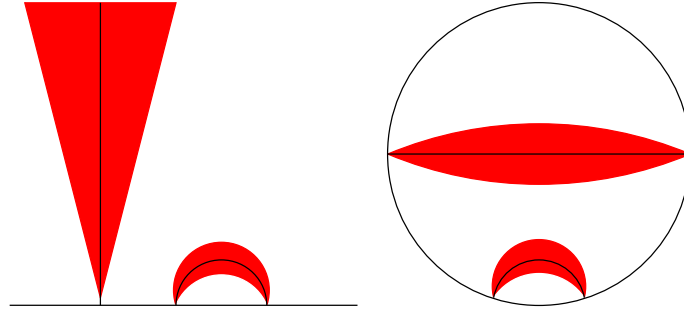

Figure 5.12 — Neighbourhoods of geodesic lines in the upper halfplane model and in the Poincaré ball model of \mathbb{H}^2 .

Lemma 5.20. *Let $L =]0, \infty[$ in the upper halfspace model of \mathbb{H}^n .*

- (1) $(0, \|x\|) \in \mathbb{R}^{n-1} \times \mathbb{R}_+$ is the unique closest point to $x \in \mathbb{R}_+^n$ in L .
- (2) The r -neighbourhood of L is the Euclidean infinite cone⁴

$$\mathcal{N}_r(L) = \left\{x \in \mathbb{R}_+^n : \cos \angle_0(L, x) > \frac{1}{\cosh r}\right\}.$$

Proof. (1) The function

$$\begin{aligned} t \mapsto \cosh d(x, \gamma_{0, \|x\|}(t)) &= 1 + \frac{x_1^2 + x_2^2 + \cdots + x_{n-1}^2 + (x_n - \|x\|e^t)^2}{2x_n\|x\|e^t} \\ &= \frac{2x_n\|x\|e^t + x_1^2 + x_2^2 + \cdots + x_{n-1}^2 + x_n^2 - 2x_n\|x\|e^t + \|x\|^2e^{2t}}{2x_n\|x\|e^t} \\ &= \frac{\|x\|^2(1 + e^{2t})}{2x_n\|x\|e^t} = \frac{\|x\|}{x_n} \cosh t \end{aligned}$$

has a unique minimum at 0, and $\gamma_{0, \|x\|}(0) = \|x\|e_n$.

(2) Exercise. □

If L' is a geodesic line in the upper halfspace model, we can map it to L by a composition of the isometries used in Proposition 5.17. These isometries are conformal maps which map the set of spheres and hyperplanes in $\widehat{\mathbb{E}}^n$ to itself. It is easy to see that the neighbourhoods $\mathcal{N}_r(L')$ are cones or bananas with opening angles at the endpoints given by Lemma 5.20, see Figure 5.12. As the isometry used to map the ball model to the upper halfspace model is an inversion, the r -neighbourhoods of geodesic lines in the ball model are bananas.

⁴ $\angle_0(L, x)$ is the angle between the Euclidean ray L and the Euclidean ray from 0 through x .

5.6 Generalized triangles in \mathbb{H}^n .

We now extend the definition of triangles and allow some of the vertices to be points at infinity of \mathbb{H}^n :

A (*generalized*) *triangle* consists of three distinct points $A, B, C \in \mathbb{H}^n \cup \partial_\infty \mathbb{H}^n$, called the *vertices*, and of the geodesic arcs, rays or lines, called the *sides*, connecting the vertices. If all vertices of a triangle Δ are in $\partial_\infty \mathbb{H}^n$, then Δ is an *ideal triangle*.

Proposition 5.21. (1) Any generalized triangle in \mathbb{H}^n is contained in an isometrically embedded copy of \mathbb{H}^2 in \mathbb{H}^n .

(2) If Δ and Δ' are ideal triangles in \mathbb{H}^n , there is an isometry $\gamma \in \text{Isom } \mathbb{H}^n$ such that $\gamma(\Delta) = \Delta'$.

Proof. Exercise. □

Next, we prove an analog of the second law of cosines for a special kind of generalized triangles. Note that the first law of cosines cannot be generalized to this setting as the triangle in question has two infinitely long sides.

Proposition 5.22. Let $A, B \in \mathbb{H}^n$ and let $C \in \partial_\infty \mathbb{H}^n$. Then

$$\cosh c = \frac{1 + \cos \alpha \cos \beta}{\sin \alpha \sin \beta}. \quad (5.3)$$

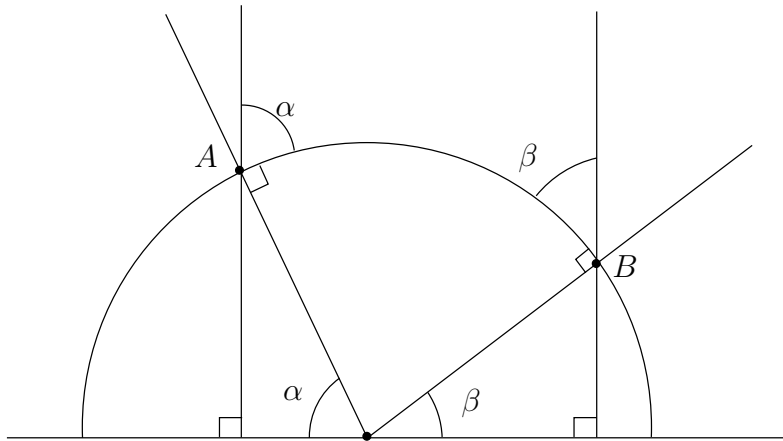

Figure 5.13 —

Proof. By proposition 5.21, it is enough to consider the hyperbolic plane. We use the upper halfplane model and normalize, using Proposition 5.17 with $x_1 = C$, x_2 and x_3 the endpoints of the geodesic line through A and B , and $y_1 = \infty$, $y_2 = -1$ and $y_3 = 1$, so that A and B are on the Euclidean unit circle and $C = \infty$.

Now, $A = (-\cos \alpha, \sin \alpha)$ and $B = (\cos \beta, \sin \beta)$. The result follows from equation (5.2), as

$$1 + \frac{\|A - B\|^2}{2A_2B_2} = 1 + \frac{(\cos \alpha + \cos \beta)^2 + (\sin \alpha - \sin \beta)^2}{2 \sin \alpha \sin \beta} = \frac{1 + \cos \alpha \cos \beta}{\sin \alpha \sin \beta}. \quad \square$$

The special case of equation (5.3) with $\beta = \frac{\pi}{2}$:

$$\cosh c = \frac{1}{\sin \alpha} \quad (5.4)$$

is known as the *angle of parallelism*. Another useful form of equation (5.4) is

$$c = \log \cot \frac{\alpha}{2}. \quad (5.5)$$

Note that equation (5.3) agrees with the second law of cosines if we define that

the angle at a vertex at infinity is 0.

From now on, we will use this convention.

5.7 Halfspaces and polytopes

Proposition 4.20 implies that hyperbolic hyperplanes are bisectors of two distinct points in \mathbb{H}^n . Using this, we can prove

Proposition 5.23. *Hyperplanes in the upper halfspace model are Euclidean hyperplanes orthogonal to the boundary at infinity or intersections with the upper halfspace of Euclidean spheres whose center is in the boundary at infinity.*

Proof. Let x, y be points in the upper halfplane model. Using equation 5.2, we see that the bisector of x and y consists of the solutions z in the upper halfspace of the equation

$$\frac{\|x - z\|}{x_n} = \frac{\|y - z\|}{y_n}. \quad (5.6)$$

If $x_n = y_n$, then equation 5.6 defines an affine plane in \mathbb{E}^n that is orthogonal to the boundary at infinity because it is a translate of the orthogonal complement of the $x - y$ whose n th coordinate is 0.

If $x_n \neq y_n$, then equation 5.6 defines a sphere centered at $\frac{y_n}{x_n - y_n}x + \frac{x_n}{y_n - x_n}y$, which is in the boundary at infinity. \square

The two connected components of the complement of a hyperplane P in \mathbb{H}^n are *open hyperbolic halfspaces*. Their closures in \mathbb{H}^n are *closed hyperbolic halfspaces*.

Lemma 5.24. *Closed and open halfspaces are convex in \mathbb{H}^n .*

Proof. Exercise. \square

If I is a finite or countable index set and $(H_i)_{i \in I}$ is a collection of closed halfplanes in \mathbb{H}^n with nonempty intersection $P = \bigcap_{i \in I} H_i$ such that $(\partial H_i)_{i \in I}$ is a locally finite collection of hyperplanes,^a then P is a *locally finite polytope* in \mathbb{H}^n .

In dimension $n = 2$, polytopes are *polygons* and in dimension $n = 3$, *polyhedra*.

^aThis means that for any compact $K \subset \mathbb{H}^n$, the set $\{i \in I : K \cap \partial H_i \neq \emptyset\}$ is finite.

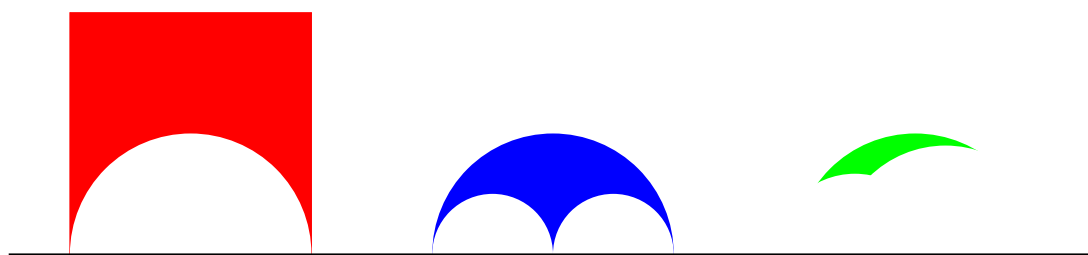

Figure 5.14 — Three polygons in the upper halfplane model of the hyperbolic plane.

Lemma 5.25. *Let X be a uniquely geodesic metric space. Let $K_\alpha \subset X$ be convex sets for all $\alpha \in A$. Then $\bigcap_{\alpha \in A} K_\alpha$ is convex or empty.*

Proof. Exercise. □

Proposition 5.26. *Polytopes in \mathbb{H}^n are convex.* □

5.8 Riemannian metrics, area and volume

The Riemannian metrics of the ball and upper halfspace models are conformal metrics: their expressions are a positive function times the Euclidean Riemannian metric of the underlying subset of \mathbb{E}^n .

The Riemannian structure defines a natural volume form and a volume measure on hyperbolic space: If V is for example an open subset of n -dimensional hyperbolic space, and λ_n is the n -dimensional Lebesgue measure, the volume of V is

$$\text{Vol}(V) = \int_V \frac{2^n d\lambda_n(x)}{(1 - \|x\|^2)^n}$$

in the Poincaré ball model and

$$\text{Vol}(V) = \int_V \frac{d\lambda_n(x)}{x_n^n}$$

in the upper halfspace model.

Proposition 5.27. *The volume of a ball in hyperbolic space is*

$$\text{Vol}(B(x, r)) = \text{Vol}(\mathbb{S}^{n-1}) \int_0^r \sinh^{n-1} t \, dt.$$

In the hyperbolic plane, we have

$$\text{Vol}(B^2(x, r)) = 4\pi \sinh^2 \frac{r}{2}$$

for all $x \in \mathbb{H}^2$.

The length of a circle of radius r in \mathbb{H}^2 is $2\pi \sinh r$.

Proof. As the isometry group acts transitively, the volume of each ball of a fixed radius is the same. Thus, it suffices to consider balls centered at the origin in the Poincaré ball model. Recall that the Euclidean radius of a ball of hyperbolic radius r centered at 0 in the Poincaré model is $\tanh \frac{r}{2}$. In order to compute the volume of the ball of radius r , recall that the Lebesgue measure is given in the spherical coordinates $(x \leftrightarrow (r, u))$ by $d\lambda_n(x) = r^{n-1} d\text{Vol}_{\mathbb{S}^{n-1}}(u)$, and thus, using a change of variables $s \leftrightarrow \tanh \frac{t}{2}$, we get

$$\begin{aligned} \text{Vol}(\mathbb{B}(x, r)) &= \text{Vol}(\mathbb{B}(0, r)) = \text{Vol}(\mathbb{S}^{n-1}) \int_0^{\tanh \frac{r}{2}} \frac{2^n s^{n-1}}{(1-s^2)^n} ds \\ &= 2^{n-1} \text{Vol}(\mathbb{S}^{n-1}) \int_0^r \sinh^{n-1} \frac{t}{2} \cosh^{n-1} \frac{t}{2} dt \\ &= \text{Vol}(\mathbb{S}^{n-1}) \int_0^r \sinh^{n-1} t dt. \end{aligned}$$

The computation of the length of a circle is left as an exercise. \square

It is clear from the expression of the volume, that for all $x \in \mathbb{H}^n$, we have

$$\text{Vol}(\mathbb{B}^n(x, r)) \sim \frac{\text{Vol}(\mathbb{S}^n)}{2^{n-1}} e^{(n-1)r},$$

as $r \rightarrow \infty$. Thus, the volume of balls in hyperbolic space grows exponentially with the radius, much faster than in Euclidean space.

Proposition 5.28. *The area of the polygon in \mathbb{H}^2 bounded by a generalized triangle with angles α , β and γ is $\pi - (\alpha + \beta + \gamma)$.*

Proof. Any triangle T can be described as the difference of two triangles with one vertex at infinity. By the additivity of area and angles in the hyperbolic plane, we may restrict to this special case. Using Proposition 5.17, we can assume that A and B are on the Euclidean unit circle and that the vertex C has been moved to infinity. Now, the area of T is

$$\int_T \frac{d\lambda_2(x)}{x_2^2} = \int_{-\cos(\alpha)}^{\cos \beta} \int_{\sqrt{1-x_1^2}}^{\infty} \frac{dx_1 dx_2}{x_2^2} = \int_{\cos(\pi-\alpha)}^{\cos \beta} \frac{dx_1}{\sqrt{1-x_1^2}} = \pi - \alpha - \beta. \quad \square$$

Exercises

- 5.1. Fill in the details of the proof of Proposition 5.4.
- 5.2. Compute the radius of the red ball in Figure 5.5.
- 5.3. Fill in the details of the proof of Proposition 5.9.
- 5.4. Prove that a ball in hyperbolic space has a unique center.
- 5.5. Compute the hyperbolic radius and center of the ball $\{z \in \mathbb{H}^2 : |z - ci| \leq 1\}$ for all $c > 1$ in the upper halfplane model of \mathbb{H}^2 .⁵
- 5.6. Prove Lemma 5.11.
- 5.7. Complete the proof of Proposition 5.12.⁶

⁵We identify the upper halfplane model of \mathbb{H}^2 with the upper halfplane in \mathbb{C} .

⁶Use Lemma 5.11 for inversions.

-
- 5.8. Prove Proposition 5.18.
- 5.9. Prove Lemma 5.20(2).
- 5.10. Prove Proposition 5.21.
- 5.11. Prove Lemma 5.24.
- 5.12. Prove Lemma 5.25.
- 5.13. Prove that the length of a circle of radius r in \mathbb{H}^2 is $2\pi \sinh r$.

Appendix A

Inversive geometry

A.1 One-point compactification

Lemma A.1. *Let (X, τ) be a topological space and let ∞ be a point that is not an element of X . Let $\hat{X} = X \cup \{\infty\}$ and let*

$$\tau_\infty = \{U \subset \hat{X} : \infty \in U \text{ and } \hat{X} - U \subset X \text{ is closed and compact}\}.$$

Then $\hat{\tau} = \tau \cup \tau_\infty$ is a topology in \hat{X} .

Proof. See the basic course in topology. □

Let X be a topological space that is not compact. The topological space \hat{X} is the *one point compactification* or the *Aleksandroff compactification* of X .

Theorem A.2. *Let (X, τ) be a topological space that is not compact. The one point compactification of X is compact and $(\bar{X})_{\hat{\tau}} = \hat{X}$. The topology of \hat{X} induces the original topology of X on X .*

Proof. Let $(U_\alpha)_{\alpha \in J}$ be an open cover of \hat{X} . There is an index $\alpha_\infty \in J$ such that $\infty \in U_{\alpha_\infty}$. The sets $U_\alpha \cap X$ form an open cover of $X - U_{\alpha_\infty}$ in X . As $X - U_{\alpha_\infty}$ is compact in X , there is some finite $J_0 \subset J$ such that $\hat{X} - U_{\alpha_\infty} \subset \bigcup_{\alpha \in J_0} U_\alpha$. The finite collection $(U_\alpha)_{\alpha \in J_0 \cup \{\alpha_\infty\}}$ is a cover of \hat{X} .

The subset X is dense in \hat{X} because, by definition, every open neighbourhood of ∞ intersects X . The topology $\hat{\tau}$ induces the topology τ in X because τ consists, by definition of elements of τ and of sets formed as the union of an element of τ and $\{\infty\}$. □

Example A.3. *The stereographic projection $\mathcal{S}: \mathbb{S}^n - \{e_3\} \rightarrow \mathbb{E}^n = \mathbb{E}^n \times \{0\} \subset \mathbb{E}^{n+1}$ is the mapping*

$$\mathcal{S}(x) = \frac{(x_1, x_2, \dots, x_n)}{1 - x_{n+1}}.$$

¹from the north pole to the level of the equator

It is a homeomorphism that maps each point $x \in \mathbb{S}^n - \{e_{n+1}\}$ to the unique point in \mathbb{E}^n (thought of as the hyperplane $\mathbb{E}^2 \times \{0\}$ in \mathbb{E}^3) on the affine line through e_{n+1} and x . Setting $\mathcal{S}(e_{n+1}) = \infty$ we obtain a homeomorphism $\mathcal{S}: \mathbb{S}^n \rightarrow \widehat{\mathbb{E}^n}$.

The one-point compactification of the Euclidean plane appears in complex analysis as the *Riemann sphere* $\mathbb{C} \cup \{\infty\}$. For example, the mapping $z \mapsto \frac{1}{z}$ becomes a self-homeomorphism of the Riemann sphere if we set $0 \mapsto \infty$ and $\infty \mapsto 0$.

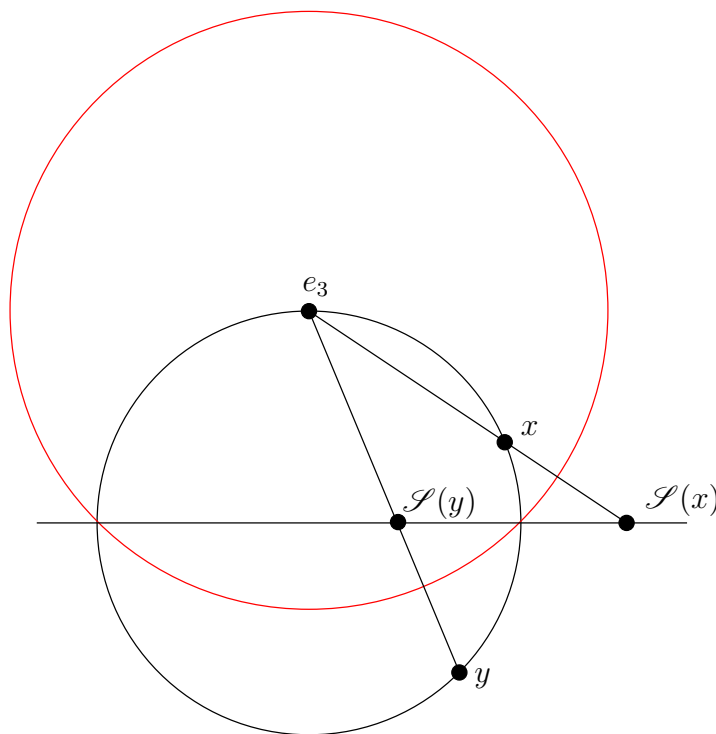

Figure A.1 — Stereographic projection is the restriction to the sphere of an inversion whose center is the

A.2 Inversions

In this short section, we review some basic material on inversions.

Let $c \in \mathbb{E}^n$ and let $\alpha \in \mathbb{R} - \{0\}$. The mapping $\iota_{c,\alpha}: \mathbb{E}^n - \{c\} \rightarrow \mathbb{E}^n - \{c\}$,

$$\iota_{c,\alpha}(x) = c + \alpha \frac{x - c}{\|x - c\|^2},$$

is an α -inversion with a *pole* at c . The number α is called the *power* of the inversion.

Example A.4. In the complex plane,

$$\iota_{0,1}(z) = \frac{z}{|z|^2} = \frac{1}{\bar{z}}.$$

Clearly, for all $x \in \mathbb{E}^n - \{c\}$, we have

$$(x - c \mid \iota_{c,\alpha}(x) - c) = \alpha$$

and $\iota_{c,\alpha} \circ \iota_{c,\alpha} = \text{id} \mid_{\mathbb{E}^n - \{0\}}$. If $\alpha > 0$, then the restriction of $\iota_{c,\alpha}$ to the sphere of center c and radius $\sqrt{\alpha}$ is the identity. The points x and $\iota(x)$ are on the same ray starting at c , and they satisfy

$$\|x - c\| \|\iota_{c,r^2}(x) - c\| = r^2.$$

Let $c \in \mathbb{E}^n$ and $r > 0$. The mapping ι_{c,r^2} is the *inversion in the sphere* of radius r centered at c .

We extend the definition of an inversion $\iota_{c,r}$ to the one-point compactification $\widehat{\mathbb{E}}^n$ of \mathbb{E}^n by setting $\iota_{c,\alpha}(c) = \infty$ and $\iota_{c,\alpha}(\infty) = c$.

Example A.5. $\iota_{e_{n+1},2} \mid_{\mathbb{S}^n} = \mathcal{S} : \mathbb{S}^n \rightarrow \widehat{\mathbb{E}}^n$.

Spheres and hyperplanes in \mathbb{E}^n are *generalized hyperplanes*.

Proposition A.6. Let $c \in \mathbb{E}^n$ and let $\alpha \in \mathbb{R} - \{0\}$. The inversion $\iota_{c,\alpha}$ maps

- (1) the affine subspaces that contain c to themselves,
- (2) spheres passing through c to affine hyperplanes that do not contain c ,
- (3) affine hyperplanes that do not contain c to spheres passing through c , and
- (4) spheres that do not pass through c to spheres that do not pass through c .

Proof. (1) is clear from the expression of the inversion.

(2) Clearly, it is enough to consider the case $c = 0$. For any $a \in \mathbb{E}^n - \{0\}$, the sphere $\partial B(a, \|a\|)$ passes through 0 and

$$\partial B(a, \|a\|) = \{x \in \mathbb{E}^n : \|x\|^2 = 2(x \mid a)\}.$$

This implies that for any $x \in \partial B(a, \|a\|)$, we have $i_{0,\alpha}(x) = \frac{\alpha x}{2(x \mid a)}$, and this gives $(i(x) \mid a) = \frac{\alpha}{2}$. Thus,

$$i_{0,\alpha}(\partial B(a, \|a\|)) = \{y \in \mathbb{E}^n : (y \mid a) = \frac{\alpha}{2}\},$$

which is a hyperplane.

(3) follows from (2) and the fact that $i_{0,\alpha}^2 = \text{id} \mid_{\mathbb{E}^n - \{0\}}$.

(4) Consider the sphere $\partial B(a, \rho)$ with $\rho \neq \|a\|$. If $x_1, x_2 \in \partial B(a, \rho)$ are on a line L (through 0), then $\frac{x_1 + x_2}{2}$ is the orthogonal projection of a on L , and we have

$$\|x_1 + x_2\|^2 + \|x_1 + x_2 - 2a\|^2 = 4\|a\|^2$$

and

$$\|x_1 - x_2\|^2 + \|x_1 + x_2 - 2a\|^2 = 4\rho^2.$$

Thus,

$$(x_1 \mid x_2) = \|a\|^2 - \rho^2,$$

and therefore $x_2 = \iota_{0, \|a\|^2 - \rho^2}(x_1)$, and we have $\iota_{0, \|a\|^2 - \rho^2}(\partial B(a, \rho)) = \partial B(a, \rho)$. A simple computation shows that for any $\alpha, \beta \in \mathbb{R} - \{0\}$, we have $\iota_\alpha \circ \iota_\beta(x) = \frac{\alpha}{\beta}x$ for all $x \neq 0$, so we get

$$\iota_{0, \alpha} = \frac{\alpha}{\|a\|^2 - \rho^2} \iota_{0, \|a\|^2 - \rho^2},$$

which implies $\iota_{0, \alpha}(\partial B(a, \rho)) = (\partial B(a, \rho))$. \square

Let D be an open subset of \mathbb{E}^n . A mapping $F: D \rightarrow \mathbb{E}^n$ is *locally conformal*, if it preserves the angles between tangent vectors. Clearly, any mapping whose differential at any point is the composition of an orthogonal transformation and a dilation is locally conformal. A homeomorphism which is a locally conformal map is called a *conformal mapping*. Sometimes one wants to be more precise and say that mappings which preserve angles and orientation are (directly) conformal and those that preserve angles but reverse the orientation are indirectly conformal.

Proposition A.7. *Let $c \in \mathbb{E}^n$ and let $\alpha \in \mathbb{R} - \{0\}$. The inversion $\iota_{c, \alpha}$ is conformal.*

Proof. Observe that $\iota_{c, \alpha} = T_c \circ \iota_{0, \alpha} \circ T_{-c}$. Translations and dilation by α are clearly conformal mappings so it suffices to prove the claim for the standard inversion $\iota_{0, 1}$. Note that

$$D\iota_{0, 1}(x) = \frac{1}{\|x\|^2} I_n - \frac{2}{\|x\|^4} x^T x,$$

where ${}^T x$ is the transpose of x when x is a column vector. Observe that ${}^T D\iota_{0, 1}(x) = D\iota_{0, 1}(x)$ and that

$$D\iota_{0, 1}(x)^2 = \frac{1}{\|x\|^2} I_3 - \frac{4}{\|x\|^6} x x^T + \frac{4}{\|x\|^8} x^T x x^T x = \frac{1}{\|x\|^2} I_n.$$

Thus, $D\iota_{0, 1}(x)$ is a multiple of an orthogonal matrix. \square

Exercises

A.1. Fill in the details Example A.5.

Part II

Negatively curved spaces

Chapter 6

Gromov-hyperbolic spaces

Gromov-hyperbolic spaces form a class of geodesic metric spaces where some geometric features are similar to hyperbolic space. There are several equivalent definitions of Gromov-hyperbolicity in the literature, most of which formalize the idea that triangles are thin or slim in these spaces in a controlled way. In this chapter, we introduce Gromov-hyperbolic spaces in the same way as they are defined in [BH] and the introduction of [GdlH]. We will also discuss the definition used by [BS], and we will show that these definitions give the same class of Gromov hyperbolic spaces.

6.1 δ -hyperbolic spaces

The first definition captures a feature of triangles in hyperbolic spaces:

Let X be a geodesic metric space and let $\delta > 0$. A triangle Δ *satisfies the Rips condition^a with constant δ* if any side of Δ is contained in the union of the closed δ -neighbourhoods of the other two.

^aor is δ -*slim* as in [BH]

Proposition 6.1. *All triangles in \mathbb{H}^n satisfy the Rips condition with constant $\log(1 + \sqrt{2})$.*

Proof. By Proposition 4.29, it suffices to consider \mathbb{H}^2 . Let x, y and z be the vertices of a nondegenerate triangle in the upper halfplane model of the hyperbolic plane. Using the transitivity properties of the isometry group,¹ we may assume that the geodesic line containing the edge $[x, y]$ is $] -1, 1[$, which is the intersection of the Euclidean unit circle with the upper halfplane. Furthermore, using reflections in the imaginary axis and the Euclidean unit circle, we may assume that $\operatorname{Re} x < \operatorname{Re} y$ and that the Euclidean distance of z from 0 is greater than 1. Using an isometry $\iota_{-1,2} \circ L_t \circ \iota_{-1,2}$ with an appropriate $t \in \mathbb{R}$, we may assume that z is in the imaginary axis as in Figure 6.1.

¹See Proposition 5.17.

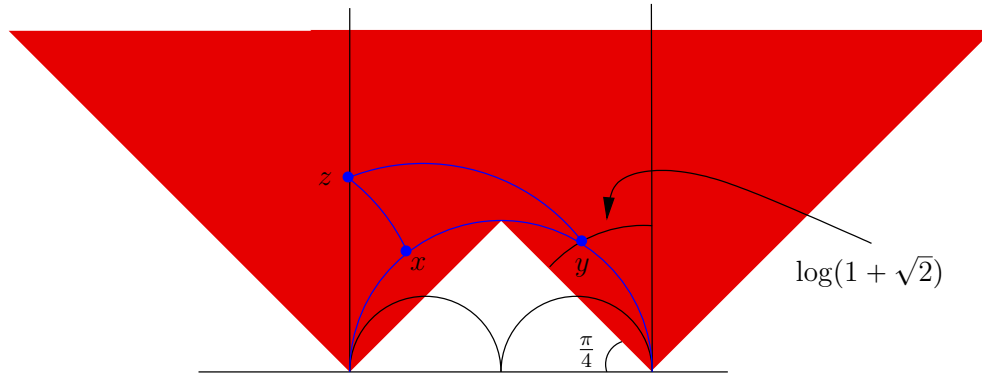

Figure 6.1 — The ideas of Example 6.2.

Let us show that $[x, y] \subset \overline{\mathcal{N}}_{\log(1+\sqrt{2})}([x, z]) \cup \overline{\mathcal{N}}_{\log(1+\sqrt{2})}([y, z])$, using the ideal triangle with vertices at 0, 1 and ∞ . If $p \in [x, y] \subset \mathbb{H}^2$, then the shortest geodesic segment from $] -1, \infty[$ to p passes through $[x, z] \cup [z, y]$, and similarly for the shortest geodesic segment from $] -1, \infty[$ to p . It is easy to check with the help of Lemma 5.20 that $] -1, 1[$ is contained in the union of the closed $\log(1 + \sqrt{2})$ -neighbourhoods² of the geodesic lines $] -1, \infty[$ and $] -1, \infty[$. Thus, the distance from p to $[x, z] \cup [z, y]$ is at most $\log(1 + \sqrt{2})$. \square

Let X be a geodesic metric space. If all triangles in X satisfy the Rips condition with constant δ , then X is a δ -hyperbolic space.
 If X is δ -hyperbolic for some $\delta > 0$, then X is a Gromov hyperbolic space.

- Example 6.2.** (1) We showed in Proposition 6.1 that \mathbb{H}^n is $\log(1 + \sqrt{2})$ -hyperbolic.
- (2) \mathbb{E}^n is not a hyperbolic space if $n \geq 2$. If Δ is a non-degenerate triangle in \mathbb{E}^n , the midpoint of any one of the sides is at a positive finite distance s from the union of the two others. If $k > 0$, the image of Δ under the homothety (stretch map) $x \mapsto kx$ is a triangle where the corresponding distance is ks . Letting k grow to ∞ proves the claim.
- (3) If X is a geodesic metric space such that the diameter $\text{diam } X$ of X is finite, then X is $\text{diam } X$ -hyperbolic. We are not interested in spaces like this.
- (4) Any \mathbb{R} -tree is 0-hyperbolic: Let X be an \mathbb{R} -tree and let $x, y, z \in X$. If $[x, y] \cap [x, z] = \{x\}$, then $[x, y] \cup [x, z]$ is an arc with endpoints y and z . Thus, it is the unique arc that joins y to z , in particular, $[x, y] \cup [x, z] = [y, z]$. If $[x, y] \cap [x, z] = [x, w]$ for some $w \neq x$, then $[w, y] \cap [w, z] = \{w\}$ and $[y, z] = [y, w] \cup [w, z] \subset [x, y] \cup [x, z]$.
- In particular, \mathbb{E}^1 is Gromov-hyperbolic.
- (5) The bi-infinite simplicial³ ladder is Gromov-hyperbolic. See Figure 6.3.

² $\text{arccosh} \frac{1}{\cos \frac{\pi}{4}} = \log(1 + \sqrt{2})$.

³Recall from section 1.4 that this means we have a metric graph with constant edge length 1.

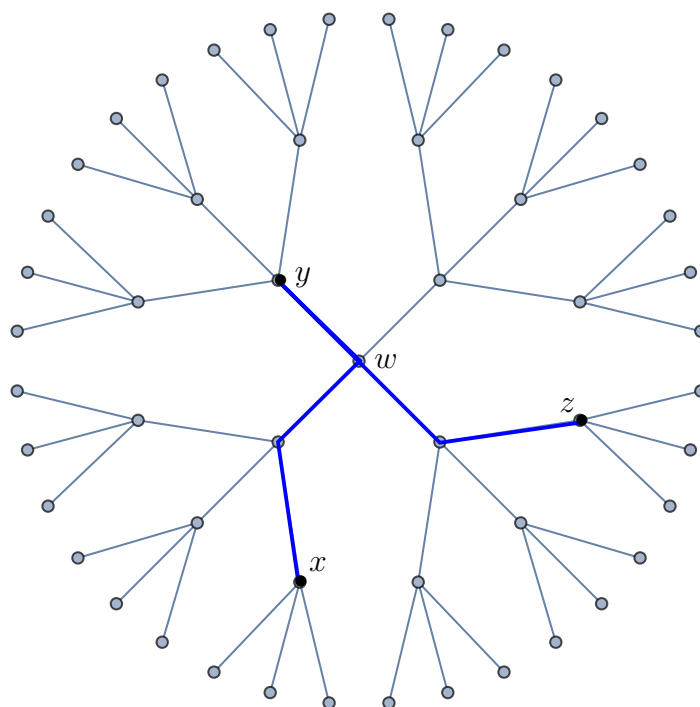

Figure 6.2 — A triangle with vertices x , y and z in a tree.

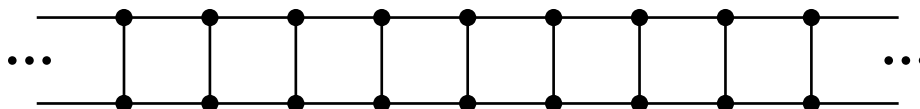

Figure 6.3 — The bi-infinite simplicial ladder.

6.2 Gromov product

Let X be a metric space and let $x, y, z \in X$. There is a unique triple of positive numbers $r_x, r_y, r_z > 0$ such that

$$\begin{cases} r_x + r_y = d(x, y) \\ r_x + r_z = d(x, z) \\ r_y + r_z = d(y, z). \end{cases} \quad (6.1)$$

The solutions to this system of equation are important enough to have a name:

Let X be a metric space and let $x, y, z \in X$. The *Gromov product* of y and z with respect to x is

$$(y|z)_x = \frac{1}{2}(d(x, y) + d(x, z) - d(y, z)).$$

Note that the triangle inequality implies that the Gromov product is nonnegative: $(y|z)_x$ for all $x, y, z \in X$ in any metric space X .

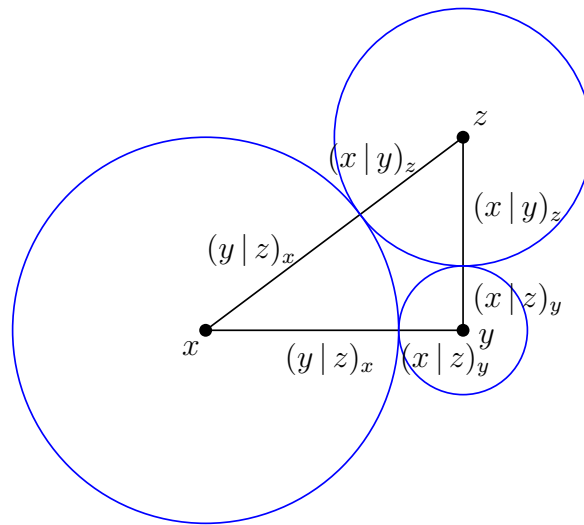

Figure 6.4 — The geometric meaning of the solution of the system (6.1).

A metric tree with three sides and four vertices such that one vertex has degree 3 and three vertices have degree 1 is a *tripod*.

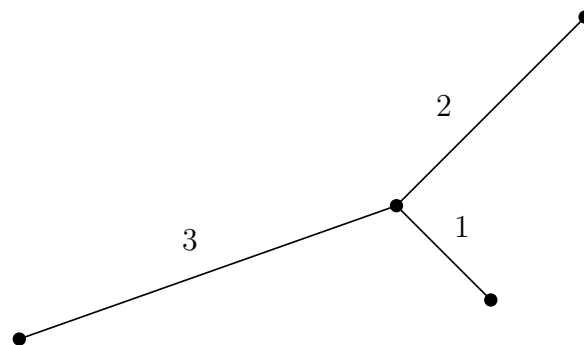

Figure 6.5 — The tripod T_Δ of a triangle Δ with side lengths 3, 4 and 5.

Lemma 6.3. *Let X be a geodesic metric space and let Δ be a triangle with vertices x, y, z . Let T_Δ be the tripod with side lengths $(y|z)_x$, $(x|z)_y$ and $(x|y)_z$. There is mapping $f_\Delta: \Delta \rightarrow T_\Delta$ such that the restriction of f_Δ to any side of Δ is an isometry.*

Proof. This is clear as the Gromov products give the solution of the system of equations (6.1). \square

Note: In many statements and proofs starting from Lemma 6.4, the notation $[a, b]$ means *some or any* geodesic segment with endpoints a and b in places where the actual choice of the possible geodesic segments is not important.

Lemma 6.4. *Let X be a geodesic metric space. Let Δ be a triangle with vertices $x, y, z \in X$. Then*

$$(y|z)_x \leq d(x, [y, z]).$$

Proof. Let $w \in [y, z]$ be a closest point to x . By Lemma 6.3, there is a point $\tilde{w} \in [x, y] \cup [x, z]$ such that $f_\Delta(w) = f_\Delta(\tilde{w})$. We may assume that $\tilde{w} \in [x, y]$. Note that $d(y, \tilde{w}) = d(y, w)$ and, as $w \in [y, z]$, $(y|z)_x \leq d(x, \tilde{w})$. Thus,

$$(y|z)_x \leq d(x, \tilde{w}) = d(x, y) - d(y, \tilde{w}) = d(x, y) - d(y, w) \leq d(x, w) = d(x, [y, z]). \quad \square$$

Let X be a geodesic metric space and let $\delta > 0$. A triangle Δ in X is δ -thin if $d(a, b) \leq \delta$ for all $b \in f_\Delta^{-1}(f_\Delta(a))$ and all $a \in \Delta$.

Lemma 6.5. *Let X be a geodesic metric space. If Δ is a δ -thin triangle with vertices $x, y, z \in X$. Then*

$$(y|z)_x \leq d(x, [y, z]) \leq (y|z)_x + \delta.$$

Proof. The first inequality holds by Lemma 6.4. To prove the second, let v_0 be the central vertex of T_Δ , and let $a \in f_\Delta^{-1}(v_0) \cap [x, y]$ and $b \in f_\Delta^{-1}(v_0) \cap [y, z]$. By assumption, we get

$$d(x, [y, z]) \leq d(x, a) + d(a, b) \leq (y|z)_x + \delta. \quad \square$$

Lemma 6.6. *A δ -thin triangle satisfies the Rips condition with constant δ .*

Proof. Exercise. □

Proposition 6.7. *Let X be a δ -hyperbolic space. Then all triangles in X are 4δ -thin.*

Proof. Assume that there is a triangle Δ with vertices $x, y, z \in X$ that is not 4δ -thin. Then (changing the names of the vertices if necessary) there are points $u \in [x, y]$ and $v \in [x, z]$ such that $f_\Delta(u) = f_\Delta(v)$ and $d(u, v) > 4\delta$. By continuity and as we are assuming a strict inequality $d(u, v) > 4\delta$, we may choose the points u and v such that

$$d(x, u) = d(x, v) < (y|z)_x. \tag{6.2}$$

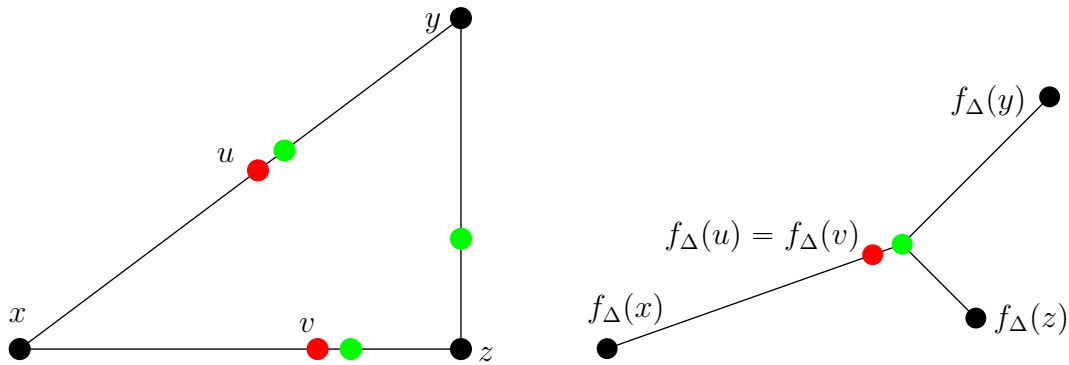

Figure 6.6 — The choice of u and v .

Lemma 6.4 applied to triangles with vertices x, u and v , and with vertices y, u and v implies that

$$d(v, [x, y]) = \min(d(v, [x, u]), d(v, [u, y])) \geq \min((x|u)_v, (y|u)_v). \tag{6.3}$$

Furthermore, using the assumption that $d(x, u) = d(x, v)$,

$$2(x | u)_v = d(x, v) + d(u, v) - d(x, u) = d(u, v)$$

and

$$\begin{aligned} 2(y | u)_v &= d(y, v) + d(u, v) - d(y, u) \\ &= d(y, v) + d(u, v) - (d(y, x) - d(x, u)) \\ &= d(u, v) + (d(y, v) + d(x, v) - d(y, x)) \\ &= d(u, v) + 2(x | y)_v \geq d(u, v) \end{aligned}$$

Combining these observations with the inequality (6.3), we get

$$d(v, [x, y]) \geq \frac{1}{2}d(u, v) > 2\delta.$$

In particular, $d(x, v) > 2\delta$ and there is a unique point $p \in [x, v]$ with $d(p, v) = \delta$ and

$$d(p, [x, y]) > \delta. \quad (6.4)$$

It remains to estimate the distance from p to $[y, z]$: Lemma 6.4 and the inequality (6.2) imply

$$\begin{aligned} d(p, [y, z]) &\geq d(x, [y, z]) - d(p, x) \geq (y | z)_x - d(p, x) \\ &> d(x, v) - d(x, p) = d(p, v) = \delta. \end{aligned} \quad (6.5)$$

The inequalities (6.4) and (6.5) show that the triangle Δ does not satisfy the Rips condition with constant δ . \square

6.3 Approximation of paths by geodesics

In this section, we prove a technical result that is useful in section 7.2. The proof makes strong use of δ -hyperbolicity.

Proposition 6.8. *Let X be a δ -hyperbolic space. Let $\gamma: [0, 1] \rightarrow X$ be a rectifiable path⁴ and let $j: [0, d(\gamma(0), \gamma(1))] \rightarrow X$ be a geodesic segment such that $j(0) = \gamma(0)$ and $j(1) = \gamma(1)$. For any $t \in [0, d(\gamma(0), \gamma(1))]$,*

$$d(j(t), \gamma([0, 1])) \leq \delta \log_2 \ell(\gamma) + 1.$$

Proof. We may assume that $\ell(\gamma) \geq 1$ and that γ is parametrized proportional to ar-length.⁵

Let $N \in \mathbb{N}$ such that $\frac{\ell(\gamma)}{2} \leq 2^N \leq \ell(\gamma)$. Let $t \in [0, d(\gamma(0), \gamma(1))]$. Let Δ_1 be a triangle with vertices $\gamma(0)$, $\gamma(1)$ and $\gamma(\frac{1}{2})$ such that one of the sides is the image of the geodesic segment j . As X is δ -hyperbolic,

$$\gamma(t) \in \overline{\mathcal{N}}_\delta\left(\left[\gamma(0), \gamma\left(\frac{1}{2}\right)\right]\right) \cup \overline{\mathcal{N}}_\delta\left(\left[\gamma\left(\frac{1}{2}\right), \gamma(1)\right]\right).$$

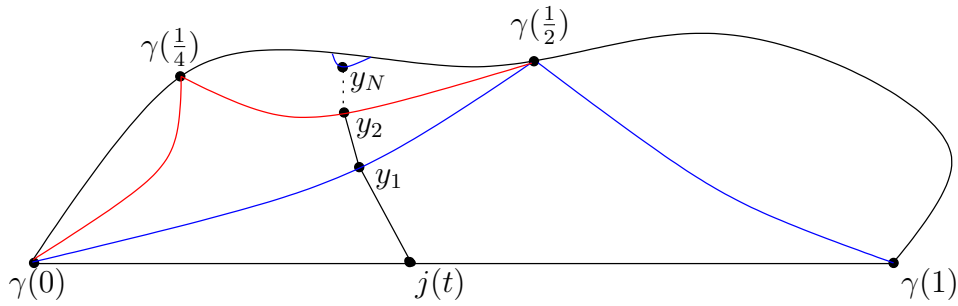

Figure 6.7 —

Thus, there is a point $y_1 \in [\gamma(0), \gamma(\frac{1}{2})] \cup [\gamma(\frac{1}{2}), \gamma(1)]$ such that $d(j(t), y_1) \leq \delta$. If $y_1 \in [\gamma(0), \gamma(\frac{1}{2})]$, let Δ_2 be a triangle with vertices $\gamma(0)$, $\gamma(\frac{1}{4})$ and $\gamma(\frac{1}{2})$. Otherwise, let Δ_2 be the triangle with vertices $\gamma(\frac{1}{2})$, $\gamma(\frac{3}{4})$ and $\gamma(1)$.

Assume that we are in the first case. Then, using δ -hyperbolicity as above, there is a point $y_2 \in [\gamma(0), \gamma(\frac{1}{4})] \cup [\gamma(\frac{1}{4}), \gamma(\frac{1}{2})]$ such that $d(y_1, y_2) \leq \delta$. We continue inductively, and construct a finite sequence of points y_1, y_2, \dots, y_N such that $d(y_k, y_{k+1}) \leq \delta$ for all $1 \leq k \leq N-1$. Note that, by construction, $y_N \in [\gamma(\frac{k}{2^N}), \gamma(\frac{k+1}{2^N})]$ for some $0 \leq k \leq 2^N - 1$, and therefore, $d(y_N, \gamma([0, 1])) \leq \frac{\ell(\gamma)}{2^{N+1}} \leq 1$. The triangle inequality gives the estimate

$$d(j(t), \gamma([0, 1])) \leq N\delta + 1 \leq \log_2 \ell(\gamma) + 1. \quad \square$$

Note that in the Euclidean plane, the distance from the center of a half-circle to the half-circle grows linearly with the radius. In the hyperbolic plane, we saw in Proposition 5.27 that the length of a circle of radius r is $2\pi \sinh r \sim \pi e^r$.

Exercises

6.1. Prove Lemma 6.6.

6.2. Let T be a simplicial tree. Let $x_0 \in X$ and let $\rho_1, \rho_2: [0, \infty[\rightarrow T$ be geodesic rays such that $\rho_1(0) = \rho_2(0) = x_0$ and $\rho_1 \neq \rho_2$. Prove that the limit $\lim_{t \rightarrow \infty} (\rho_1(t) | \rho_2(t))_{x_0}$ exists.⁶

6.3. Let $\rho_1, \rho_2: [0, \infty[\rightarrow \mathbb{H}^2$ be geodesic rays such that $\rho_1(0) = \rho_2(0) = 0$ in the Poincaré disk model and $\rho_1 \neq \rho_2$. Prove that $(\rho_1(t) | \rho_2(t))_0$ is bounded.⁷

6.4. Let $\rho_1, \rho_2: [0, \infty[\rightarrow \mathbb{E}^2$ be geodesic rays such that $\rho_1(0) = \rho_2(0) = 0$ and $\rho_1 \neq -\rho_2$. Prove that $(\rho_1(t) | \rho_2(t))_0$ is not bounded.

⁴A path γ is *rectifiable* if $\ell(\gamma) < \infty$.

⁵See [BH, Remark I.1.22] for the second assumption.

⁶Prove that the function $t \mapsto (\rho_1(t) | \rho_2(t))_{x_0}$ is constant for large t .

⁷Lemma 6.5 and Proposition 4.26 can be useful.

Chapter 7

Quasi-isometries and hyperbolicity

In this chapter, we introduce quasi-isometric embeddings and quasi-isometries that are important classes of mappings in *coarse geometry*. These mappings distort large distances moderately but in smaller scale they may behave badly but not too badly. In particular, quasi-isometric embeddings are allowed to have discontinuities and not to be injective.

In sections 7.4 and 7.5 we discuss some basic objects of geometric group theory and group actions on geodesic metric spaces. We conclude the chapter with a proof of an important result of Švarc and Milnor.

7.1 Quasi-isometric embeddings and quasi-isometries

In this section, we study a class of mappings between metric spaces that is natural in the study of the large scale geometry of metric spaces.

Let (X, d_X) and (Y, d_Y) be metric spaces and let $\lambda \geq 1$, $c \geq 0$. A mapping $F: X \rightarrow Y$ is a (λ, c) -quasi-isometric embedding if

$$\frac{1}{\lambda}d_X(x, x') - c \leq d_Y(F(x), F(x')) \leq \lambda d_X(x, x') + c$$

for all $x, x' \in X$.

The definition of quasi-isometric embeddings does not require continuity or injectivity of the mapping. In particular, that quasi-isometric embeddings do not have to be embeddings in the usual sense.

Example 7.1. (1) Isometric embeddings are $(1, 0)$ -quasi-isometric embeddings.

(2) If X is a bounded metric space and $x_0 \in X$, then the constant mapping $x \mapsto x_0$ is a quasi-isometric embedding. The inclusion mapping $\{x_0\} \hookrightarrow X$ is a quasi-isometric embedding.

The *floor*, *ceiling* and *nearest integer* functions are defined by setting for all $t \in \mathbb{E}$,

$$\begin{aligned} \lfloor t \rfloor &= \max\{m \in \mathbb{Z} : m \leq t\}, \\ \lceil t \rceil &= \min\{m \in \mathbb{Z} : m \geq t\}, \text{ and} \\ [t] &= \begin{cases} \lfloor t \rfloor, & \text{if } t \in \bigcup_{n \in \mathbb{Z}} [n, n + \frac{1}{2}] \\ \lceil t \rceil, & \text{otherwise.} \end{cases} \end{aligned}$$

In the definition of the nearest integer mapping, we have made a choice for the elements of $\mathbb{Z} + \frac{1}{2}$ to map them to the smaller of the two nearest integers.

Example 7.2. The functions $\lfloor \cdot \rfloor, \lceil \cdot \rceil, [\cdot]$: $\mathbb{E}^1 \rightarrow \mathbb{Z}$ are $(1, 1)$ -quasi-isometric embeddings.

Let $I \subset \mathbb{E}^1$ be an interval. A (λ, c) -isometric embedding $i: I \rightarrow X$ is a (λ, c) -*quasigeodesic*. More precisely, it is

- (1) a (λ, c) -*quasigeodesic segment*, if $I = [0, b]$ is a (closed) bounded interval,
- (2) a (λ, c) -*quasigeodesic ray*, if $I = [0, +\infty[$, and
- (3) a (λ, c) -*quasigeodesic line*, if $I = \mathbb{E}^1$.

Lemma 7.3. Let X, Y and Z be metric spaces.

- (1) If $F: X \rightarrow Y$ is a (λ_F, c_F) -quasi-isometric embedding and $G: Y \rightarrow Z$ is a (λ_G, c_G) -quasi-isometric embeddings, then $G \circ F$ is a $(\lambda_G \lambda_F, \lambda_G c_F + c_G)$ -quasi-isometric embedding.
- (2) If $j: I \rightarrow X$ is a geodesic and $F: X \rightarrow Y$ is a (λ, c) -quasi-isometric embedding, then $F \circ j$ is a (λ, c) -quasigeodesic.

Proof. Exercise. □

Let (X, d_X) and (Y, d_Y) be metric spaces and let $\lambda \geq 1, c \geq 0$. If $F: X \rightarrow Y$ and $\bar{F}: Y \rightarrow X$ are quasi-isometric embeddings and there is a constant $K \geq 0$ such that

$$d_X(x, \bar{F} \circ F(x)) \leq K$$

and

$$d_Y(y, F \circ \bar{F}(y)) \leq K$$

for all $x \in X$ and all $y \in Y$, then F is a *quasi-isometry*, \bar{F} is a *quasi-inverse* of F , and X and Y are *quasi-isometric* spaces.

Lemma 7.4. If $F: X \rightarrow Y$ and $G: Y \rightarrow Z$ be quasi-isometries, then $G \circ F$ is a quasi-isometry.

Proof. Let \bar{F} and \bar{G} be the quasi-inverses of F and G . Lemma 7.3 implies that $G \circ F$ and $\bar{F} \circ \bar{G}$ are quasi-isometric embeddings. Let $K \geq 0$ be such that $d(y, \bar{G} \circ G(y)) \leq K$ for all $y \in Y$, and let \bar{G} be a (λ, c) quasi-isometric embedding. Now, $d(F(x), \bar{G} \circ G(F(x))) \leq K$ for all $x \in X$, and thus,

$$\begin{aligned} d(x, (\bar{F} \circ \bar{G}) \circ (G \circ F)(x)) &\leq d(x, \bar{F}(F(x))) + d(\bar{F}(F(x)), \bar{F}(\bar{G} \circ G(F(x)))) \\ &\leq \lambda K + c \end{aligned}$$

for all $x \in X$. The corresponding estimate for $d(y, (G \circ F) \circ (\overline{F} \circ \overline{G})(y))$ is shown in the same way. Thus, $\overline{F} \circ \overline{G}$ is a quasi-inverse of $G \circ F$. \square

Example 7.5. (1) If X is a bounded metric space and $x_0 \in X$, then the constant mapping $x \mapsto x_0$ is a quasi-isometry, the identity is its quasi-inverse.

(2) The functions $[\cdot], [\cdot], [\cdot]: \mathbb{E}^1 \rightarrow \mathbb{Z}$ are quasi-isometries. These three functions are quasi-inverses of the inclusion map $\mathbb{Z} \hookrightarrow \mathbb{E}^1$.

Proposition 7.6. Let (X, d_X) and (Y, d_Y) be metric spaces. Let $F: X \rightarrow Y$ be a quasi-isometric embedding such that $\sup\{d_Y(y, F(X)) : y \in Y\} < \infty$.¹ Then F is a quasi-isometry.

Proof. Exercise. \square

Example 7.7. The space \mathbb{Z}^n with the metric induced from \mathbb{E}^n is quasi-isometric with \mathbb{E}^n : the inclusion map is an isometric embedding and $d(x, \mathbb{Z}^n) \leq \frac{\sqrt{n}}{2}$ for all $x \in \mathbb{E}^n$.

The main result of this chapter is the stability of Gromov-hyperbolicity under quasi-isometries. We will prove it at the end of section 7.3 as a corollary of the results in section 7.2.

Theorem 7.8. Let X and Y be geodesic metric spaces. If X and Y are quasi-isometric, then X is Gromov-hyperbolic if and only if Y is Gromov-hyperbolic.

7.2 Stability of quasigeodesics

In this section, we will prove that the image of a (λ, c) -quasigeodesic segment in a δ -hyperbolic space is not far from a geodesic segment connecting its endpoints, and that the distance of these two sets depends only on the parameters λ , c and δ .

Let X be a metric space. The *Hausdorff distance* of two nonempty subsets $A, B \subset X$ is

$$d_{\text{Haus}}(A, B) = \inf\{\varepsilon > 0 : A \subset \mathcal{N}_\varepsilon B, \text{ and } B \subset \mathcal{N}_\varepsilon A\}.$$

The *Hausdorff distance* of mappings $f, g: Z \rightarrow X$ is

$$d_{\text{Haus}}(f, g) = d_{\text{Haus}}(f(Z), g(Z)).$$

We use the Hausdorff distance to measure how much two subsets of a metric space differ but, in the general case, Hausdorff distance is not a metric because the distance of a bounded set and an unbounded set is infinite and because the Hausdorff distance of a set and its closure is 0.

Let $E \neq \emptyset$. A function $d: E \times E \rightarrow [0, \infty]$ is an *extended pseudometric* in E if

- (1) $d(x, x) = 0$ for all $x \in E$,
- (2) $d(x, y) = d(y, x)$ for all $x, y \in E$, and
- (3) $d(x, y) \leq d(x, z) + d(z, y)$ for all $x, y, z \in E$ (the *triangle inequality*).

¹The image $F(X)$ is *quasidense* in Y .

Lemma 7.9. *Let X be a metric space. Hausdorff distance is an extended pseudometric in the set of nonempty subsets of X .*

Proof. Exercise. □

Theorem 7.10. *Let $\delta \geq 0$, $\lambda \geq 1$ and $c \geq 0$. There is a constant $R = R(\delta, \lambda, c) \geq 0$ such that the following holds: If $\gamma: I \rightarrow X$ is a (λ, c) -quasigeodesic segment in a δ -hyperbolic space X , then the Hausdorff distance of $\gamma(I)$ from any geodesic segment with the same endpoints as γ is at most R .*

Proof. Let $\gamma: [0, b] \rightarrow X$ be a (λ, c) -quasigeodesic segment. For convenience, to replace b by an integer, let $\gamma_1: [0, [b]] \rightarrow X$,

$$\gamma_1(t) = \begin{cases} \gamma(t), & \text{if } t \in [0, b] \\ \gamma(b) & \text{otherwise.} \end{cases}$$

The mapping γ_1 is a $(\lambda, c + 1)$ -quasigeodesic segment that has the same image as γ .

Step 1. First, we construct a continuous quasigeodesic segment γ_2 close to γ_1 . Let $\sigma_i: [i - 1, i] \rightarrow X$ be affinely reparametrized geodesic arcs or constant mappings such that $\sigma_i(i - 1) = \gamma_1(i - 1)$ and $\sigma_i(i) = \gamma_1(i)$ for all $i \in \{1, 2, \dots, [b]\}$. Let

$$\gamma_2 = \sigma_1 * \sigma_2 * \dots * \sigma_b.$$

This mapping is continuous as the product (or concatenation) of geodesic arcs.

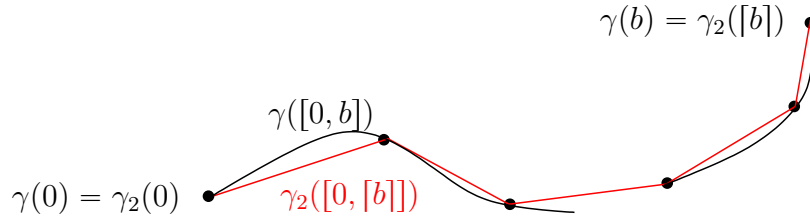

Figure 7.1 — The possibly disconnected quasigeodesic arc γ and a continuous quasigeodesic arc γ_2 .

As γ_1 is a $(\lambda, c + 1)$ -quasigeodesic segment, we have

$$d(\gamma_1(i - 1), \gamma_1(i)) \leq \lambda + c + 1 \tag{7.1}$$

for all $i \in \{1, 2, \dots, [b]\}$. As σ_i is parametrized relative to the arclength for all i , this implies $d(\gamma_2(t), \gamma_2([t])) \leq \frac{\lambda + c + 1}{2}$ for all $t \in [0, [b]]$. By the $(\lambda, c + 1)$ -quasigeodesicity of γ_1 , we have

$$d(\gamma_1(t), \gamma_1([t])) \leq \lambda |t - [t]| + c + 1 \leq \frac{\lambda}{2} + c + 1$$

for all $t \in [0, [b]]$. The triangle inequality and the fact that the mappings γ_1 and γ_2 coincide at the integers gives now

$$d(\gamma_1(t), \gamma_2(t)) \leq \lambda + \frac{3}{2}(c + 1),$$

and as a consequence,

$$d_{\text{Haus}}(\gamma_1([0, [b]]), \gamma_2([0, [b]])) \leq \lambda + \frac{3}{2}(c+1). \quad (7.2)$$

It remains to show that γ_2 is quasigeodesic. Let $0 \leq t, t' \leq [b]$. Using the triangle inequality, the fact that γ_1 and γ_2 agree at the integers in $[0, [b]]$ and the definition of a quasigeodesic segment, we get the estimate

$$\begin{aligned} d(\gamma_2(t), \gamma_2(t')) &\leq d(\gamma_2([t]), \gamma_2([t'])) + d(\gamma_2(t), \gamma_2([t])) + d(\gamma_2(t'), \gamma_2([t'])) \\ &\leq d(\gamma_1([t]), \gamma_1([t'])) + \frac{\lambda + c + 1}{2} + \frac{\lambda + c + 1}{2} \\ &\leq \lambda|[t] - [t']| + c + 1 + \lambda + c + 1 \\ &\leq \lambda|t - t'| + \lambda + 2c + 2 + \lambda, \end{aligned}$$

and, similarly,

$$\begin{aligned} d(\gamma_2(t), \gamma_2(t')) &\geq d(\gamma_2([t]), \gamma_2([t'])) - (\lambda + c + 1) \\ &\geq \frac{1}{\lambda}|[t] - [t']| - (\lambda + 2(c + 1)) \\ &\geq \frac{1}{\lambda}|t - t'| - \frac{1}{\lambda} - (\lambda + 2(c + 1)). \end{aligned} \quad (7.3)$$

Combining these two estimates show that γ_2 is a $(\lambda, 2(\lambda + c + 1))$ -quasigeodesic segment.

Step 2. Let $j: [0, d(\gamma(0), \gamma(b))] \rightarrow X$ be a geodesic segment such that $j(0) = \gamma(0)$ and $j(1) = \gamma(1)$. We now prove that there is a constant $H = H(\delta, \lambda, c)$ such that

$$j([0, d(\gamma(0), \gamma(b))]) \subset \overline{\mathcal{N}}_H(\gamma_2([0, [b]])).$$

By continuity and compactness,

$$D = \max \{d(j(t), \gamma_2([0, [b]])) : t \in [0, d(\gamma(0), \gamma(b))]\} < \infty.$$

Let $t_0 \in [0, d(\gamma(0), \gamma(b))]$ such that $d(j(t_0), \gamma_2([0, [b]])) = D$. In particular,

$$d(\gamma(0), j(t_0)), d(\gamma(1), j(t_0)) \geq D$$

and $B(j(t_0), D) \cap \gamma_2([0, [b]]) = \emptyset$.

Let $t_- = \max(0, t_0 - 2D)$ and $t_+ = \min(0, t_0 + 2D)$. Let $z_-, z_+ \in \gamma_2([0, [b]])$ such that $d(j(t_-), z_-), d(j(t_+), z_+) \leq D$. Let $s_-, s_+ \in [0, 1]$ such that $z_{\pm} = \gamma_2(s_{\pm})$. Let η be the path obtained by concatenating a geodesic segment from $j(t_-)$ to z_- , $\gamma_2|_{[s_-, s_+]}$ and a geodesic segment from z_+ to $j(t_+)$. The distance from $j(t_0)$ to the image of η is at least D and the triangle inequality implies that

$$d(z_-, z_+) \leq 6D. \quad (7.4)$$

Recall that γ_2 is a concatenation of reparametrized geodesic arcs and constant mappings. Thus, using equation (7.1), we have

$$\ell(\gamma_2|_{[s_-, s_+]}) \leq (\lambda + c + 1)([s_+] - [s_-] + 2).$$

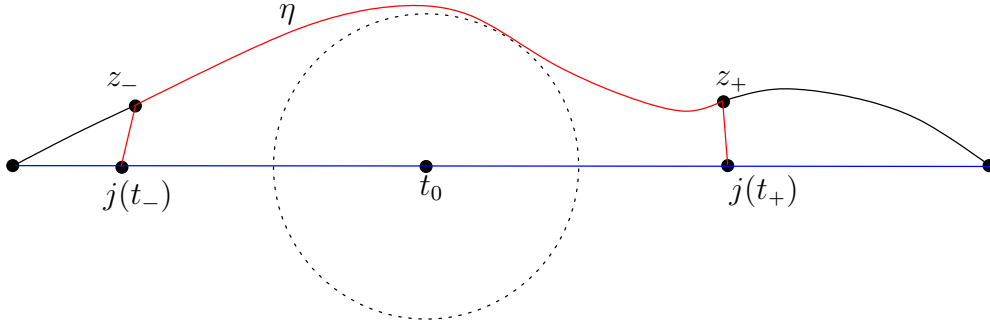

Figure 7.2 — The path η .

Combining this with the inequalities (7.3) and (7.4), we get that there are nonnegative constants K, K' such that

$$\ell(\eta) \leq KD + K' + 2D = (K + 2)D + K'.$$

Proposition 6.8 gives the estimate

$$D \leq \delta \log_2 \ell(\eta) + 1 \leq \delta \log_2 (K + 2)D + K' + 1.$$

This inequality does not hold for large D and it gives the existence of an upper bound D_0 for D that only depends on δ, λ and c . We have proved that

$$j([0, d(\gamma(0), \gamma(b))]) \subset \overline{\mathcal{N}}_{D_0}(\gamma_2([0, [b]])). \quad (7.5)$$

Step 3. Let $[u, v] \subset [0, [b]]$ be a maximal interval such that $\gamma_2([u, v])$ is contained in the complement of $\mathcal{N}_{D_0+1}(j([0, d(\gamma(0), \gamma(b))]))$. Note that by (7.5),

$$j([0, d(\gamma(0), \gamma(b))]) \subset \mathcal{N}_{D_0+1}(\gamma_2|_{[0, u[)}) \cup \mathcal{N}_{D_0+1}(\gamma_2|_{]v, [b]})).$$

As $j([0, d(\gamma(0), \gamma(b))])$ is connected and its subsets $j([0, d(\gamma(0), \gamma(b))]) \cap \mathcal{N}_{D_0+1}(\gamma_2|_{[0, u[})$ and $j([0, d(\gamma(0), \gamma(b))]) \cap \mathcal{N}_{D_0+1}(\gamma_2|_{]v, [b]})$ are nonempty, they must intersect. Thus, there are $u' \in [0, u[$, $v' \in]v, [b]$ and $t_0 \in [0, d(\gamma(0), \gamma(b))]$ such that

$$d(\gamma_2(u'), j(t_0)), d(\gamma_2(v'), j(t_0)) < D_0 + 1.$$

In particular, $d(\gamma_2(u'), \gamma_2(v')) < 2(D_0 + 1)$. As in Step 2, this implies

$$\ell(\gamma_2|_{[u', v']}) \leq 2K(D_0 + 1) + K',$$

and we see that

$$\gamma_2([0, [b]]) \subset \overline{\mathcal{N}}_{(K+1)(D_0+1) + \frac{K'}{2}}(j([0, d(\gamma(0), \gamma(b))])). \quad (7.6)$$

Equations (7.2), (7.5) and (7.6) give the claim of the theorem. \square

7.3 Quasitriangles and the proof of Theorem 7.8

In this section, we introduce quasitriangles that are made up of quasigeodesic arcs and use this tool to prove the invariance of Gromov-hyperbolicity under quasi-isometries.

Let X be a metric space and let $\lambda \geq 1$ and $c \geq 0$. A (λ, c) -*quasitriangle* in X is a triple $q\Delta = \{j_1, j_2, j_3\}$ of (λ, c) -quasigeodesic segments such that the terminus of j_i is the origin of j_{i+1} with the index i considered cyclically mod 3.

The quasigeodesic segments j_1, j_2 and j_3 are the *sides* of $q\Delta$.

The endpoints of the quasigeodesic segments j_1, j_2 and j_3 are the *vertices* of Δ .

Lemma 7.3 implies that the image of a triangle by a quasi-isometric embedding is a quasitriangle. Naturally, we extend the Rips condition² to quasitriangles:

Let X be a geodesic metric space and let $\delta > 0$. A quasitriangle $q\Delta$ *satisfies the Rips condition (for quasigeodesic triangles) with constant M* if any side of $q\Delta$ is contained in the union of the closed M -neighbourhoods of the other two.

Corollary 7.11. *Let X be a δ -hyperbolic space and let $\lambda \geq 1$ and $c \geq 0$. There is a constant $M = M(\delta, \lambda, c)$ such that all (λ, c) -quasitriangles of X satisfy the Rips condition with constant M .*

Proof. Exercise □

Theorem 7.12. *Let X be a geodesic metric space and let Y be a δ -hyperbolic space. Let $F: X \rightarrow Y$ be a (λ, c) -quasi-isometric embedding. Then there is a constant δ' such that X is δ' -hyperbolic.*

Proof. Let $j_1: I_1 \rightarrow X$, $j_2: I_2 \rightarrow X$, $j_3: I_3 \rightarrow X$ be the sides of a triangle Δ in X . Corollary 7.11 implies that the quasitriangle with sides $F \circ j_1$, $F \circ j_2$ and $F \circ j_3$ is $M(\delta, \lambda, c)$ -thin.

Let $t \in I_1$. Corollary 7.11 implies that there is some $s \in I_2 \cup I_3$ such that

$$d(F \circ j_1(t), F \circ j_k(s)) \leq M(\delta, \lambda, c),$$

where $k \in \{1, 2\}$. This implies that

$$d(j_1(t), j_k(s)) \leq \lambda d(F \circ j_1(t), F \circ j_k(s)) + c \leq \lambda M(\delta, \lambda, c) + c,$$

and the analogous estimate for the sides j_2 and j_3 . Thus, Δ satisfies the Rips condition with constant $\delta' = \lambda M(\delta, \lambda, c) + c$. □

Proof of Theorem 7.8. Let $F: X \rightarrow Y$ be a quasi-isometry let $\bar{F}: Y \rightarrow X$ be its quasi-inverse. Theorem 7.12 applied to these two mappings implies the claim. □

²See section 6.1.

7.4 Hyperbolic groups

Simplicial graphs associated with finitely generated groups are important examples in the theory of Gromov-hyperbolic spaces.

A subset $S \subset G$ is a *symmetric set of generators* of G if S generates G and $s \in S$ if and only if $s^{-1} \in S$ and the identity element of G is not in S .

A group G is *finitely generated* if it has a finite generating set.

Let G be a group and let S be a symmetric set of generators of G . The *Cayley graph* $\mathcal{G}(G, S)$ is the graph with $V\mathcal{G}(G, S) = G$ and $E\mathcal{G}(G, S) = G \times S$, $o(g, s) = g$, $t(g, s) = gs$ and $(g, s) = (gs, s^{-1})$.

The simplicial graph defined on $\mathcal{G}(G, S)$ is also called the *Cayley graph* $\mathcal{G}(G, S)$.

Example 7.13. (1) The set $S = \{-3, -2, 2, 3\} \subset \mathbb{Z}$ is a finite symmetric set of generators of the additive group of integers \mathbb{Z} . The Cayley graph $\mathcal{G}(\mathbb{Z}, S)$ looks very different from the Cayley graph $\mathcal{G}(\mathbb{Z}, \{-1, 1\})$ shown in Example 1.10(1).

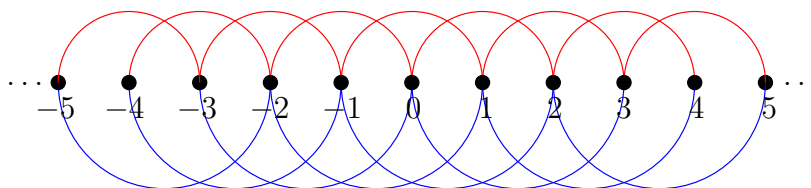

Figure 7.3 — Part of the Cayley graph $\mathcal{G}(F_2, \{a, b, a^{-1}, b^{-1}\})$ of the free group on two generators.

(2) A *word* on the *alphabet* $\mathcal{A} = \{a, b, a^{-1}, b^{-1}\}$ is a finite sequence $s_1 s_2 \dots s_n$ with $n \in \mathbb{N}$ and $s_i \in \mathcal{A}$ for all $i \in \{1, 2, \dots, n\}$, including the empty word e that corresponds to $n = 0$. A word is *reduced* if it does not include subwords aa^{-1} , $a^{-1}a$, bb^{-1} or $b^{-1}b$. We denote the set of reduced words by $\mathcal{R}(\mathcal{A})$. If $u = s_1 \dots s_m$ and $w = t_1 \dots t_n$ are reduced words on \mathcal{A} , the *juxtaposition* $u*w$ of u and w is the word obtained by successively deleting the forbidden subwords from the word $s_1 \dots s_m t_1 \dots t_n$. The *free group on two generators* is the group $F_2 = (\mathcal{R}(\mathcal{A}), *)$. See [Rot, Ch. 11]. The Cayley graph $\mathcal{G}(F_2, \{a, b, a^{-1}, b^{-1}\})$ is the regular tree of degree 4, see figure 7.4.

Let G be a group and let S be a symmetric set of generators of G . The *word metric* d_S in G associated with the generating set S is defined by

$$d_S(g, h) = \min\{n \in \mathbb{N} : g^{-1}h = s_1 s_2 \dots s_n, \quad s_1, s_2, \dots, s_n \in S\}.$$

Note that, if G is a group, $e \in G$ is the identity element and $S \subset G$ is a symmetric generating set, by construction,

$$d_S(g, h) = d_S(e, g^{-1}h). \quad (7.7)$$

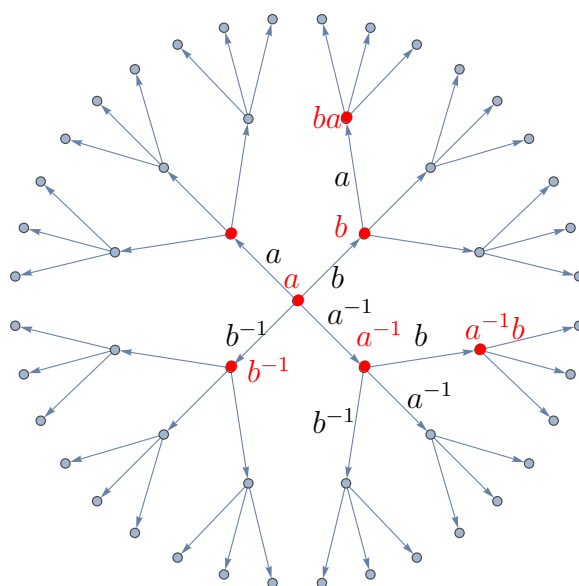

Figure 7.4 — Part of the Cayley graph $\mathcal{G}(F_2, \{a, b, a^{-1}, b^{-1}\})$ of the free group on two generators.

Lemma 7.14. *The metric of the simplicial graph $\mathcal{G}(G, S)$ induces a metric on $V\mathcal{G}(G, S)$ such that the identity map $G \rightarrow G = V\mathcal{G}(G, S)$ is an isometric embedding.*

Proof. Exercise. □

Lemma 7.15. *Let G be a group and let S be a symmetric set of generators of G . The metric spaces $\mathcal{G}(G, S)$ and (G, d_S) are quasi-isometric.*

Proof. The claim follows from Lemma 7.14, Proposition 7.6 and the fact that $\mathcal{G}(G, S) = \overline{\mathcal{N}}_{\frac{1}{2}}(V\mathcal{G}(G, S))$. □

Lemma 7.16. *Let S and T be finite symmetric generating sets of a group G . The identity map $\text{id}: (G, d_S) \rightarrow (G, d_T)$ is a quasi-isometry.*

Proof. Exercise. □

Proposition 7.17. *Let S and T be finite symmetric generating sets of a group G . The Cayley graphs $\mathcal{G}(G, S)$ and $\mathcal{G}(G, T)$ are quasi-isometric.*

Proof. The claim follows from Lemmas 7.15, 7.16 and 7.4. □

Proposition 7.17 and Theorem 7.8 imply that the following definition makes sense:

A finitely generated group G is a *hyperbolic group* if $\mathcal{G}(G, S)$ is Gromov-hyperbolic for some symmetric generating set S of G .

Example 7.18. (1) The free group on two generators is a hyperbolic group. In fact, the free group on n generators is hyperbolic for all $n \in \mathbb{N}$, its Cayley graph with respect to a symmetric set of free generators is a tree with degree $2n$.

(2) The word metric of the symmetric generating set $S = \{\pm e_i : 1 \leq i \leq n\}$ in \mathbb{Z}^n coincides with the induced metric of the norm $\|\cdot\|_1$ of \mathbb{R}^n , which is equivalent with the Euclidean metric. This observation combined with Example 7.7 shows that \mathbb{Z}^n with any word metric is quasi-isometric with \mathbb{E}^n . In particular, \mathbb{Z}^n is not hyperbolic for $n \geq 2$ by Theorem 7.8 and Example 6.2(2).

7.5 Group actions and the Švarc-Milnor lemma

Let $S(A)$ be the group of permutations of a set A . A group G *acts on* A if there is a homomorphism $\phi: G \rightarrow S(A)$. The homomorphism ϕ is an *action* of G on A .

Let X be a topological space. A group G *acts on* (X, d) *by homeomorphisms* if there is a homomorphism $\phi: G \rightarrow \text{Homeo}(X, d)$.

Let (X, d) be a metric space. A group G *acts on* (X, d) *by isometries* if there is a homomorphism $\phi: G \rightarrow \text{Isom}(X, d)$.

If a group G acts on a set A and will use the notation

$$g \cdot a = \phi(g)(a) = (\phi(g))(a)$$

for all $g \in G$ and all $a \in A$. If the group is a subgroup of the permutation group of A , the notation $g(a)$ is natural to use, and if we have an action of a group of matrices on a vector space with a fixed basis, the usual notation of matrix multiplication is used.

Example 7.19. Any finitely generated group acts on itself and on its Cayley graph by isometries. If G is a group and $g \in G$, the mapping $L_g: G \rightarrow G$, $L_g(g') = gg'$, is *left multiplication* by g . If S is a finite symmetric generating set of G , then

$$\begin{aligned} d_S(gg_1, gg_2) &= \min\{n \in \mathbb{N} : (gg_1)^{-1}gg_2 = g_1^{-1}g_2 = s_1s_2 \cdots s_n, \quad s_1, s_2, \dots, s_n \in S\} \\ &= d_S(g_1, g_2) \end{aligned}$$

for all $g, g_1, g_2 \in G$. Thus, the mappings L_g are isometries. As $L_{gh} = L_g \circ L_h$ for all $g, h \in G$, we see that the mapping $g \mapsto L_g$ is an action by isometries on (G, d_S) . Consequently, it induces an isometry of the Cayley graph.

Lemma 7.20. *Let X be a metric space and let G be a finitely generated group that acts on X by isometries and let $x_0 \in X$. For any symmetric generating set S of G , there is a constant M such that*

$$d(g_1 \cdot x_0, g_2 \cdot x_0) \leq M d_S(g_1, g_2)$$

for all $g_1, g_2 \in G$.

Proof. Let

$$M = \max\{d(x_0, s \cdot x_0) : s \in S\}.$$

Let $g \in G$ and let $s_1, s_2, \dots, s_n \in S$ such that $g = s_1s_2 \cdots s_n$, and let $g_k = s_1s_2 \cdots s_k$ for all $1 \leq k \leq n$ and let $g_0 = e$ be the identity of G . The triangle inequality and the fact that G acts by isometries give

$$d(x_0, g \cdot x_0) \leq \sum_{k=1}^n d(g_{k-1} \cdot x_0, g_k \cdot x_0) = \sum_{k=1}^n d(x_0, s_k \cdot x_0) \leq nM.$$

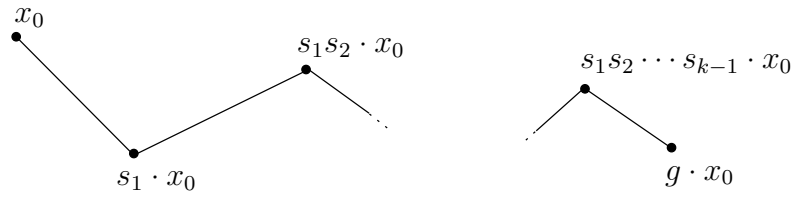

Thus, $d(x_0, g \cdot x_0) \leq Md_S(e, g)$. Equation (7.7) and the fact that G acts by isometries implies the claim:

$$d(g_1 \cdot x_0, g_2 \cdot x_0) = d(x_0, g_1^{-1}g_2 \cdot x_0) \leq Md_S(e, g_1^{-1}g_2) = Md_S(g_1, g_2) \quad \square$$

Let A be a set and let G be a group that acts on A . If $a \in A$, the set

$$G \cdot a = \{g \cdot a : g \in G\}$$

is the G -orbit of a . The *quotient set*^a is

$$G \backslash A = \{G \cdot a : a \in A\}.$$

If X is a topological space, the *quotient space* of X by G is the set $G \backslash X$ with the quotient topology of the equivalence relation defined by the partition of X to G -orbits. The mapping $\pi: X \rightarrow G \backslash X$, $\pi(x) = G \cdot x$, is the *canonical projection*.

The action by homeomorphisms of a group G on a topological space X is *cocompact* if $G \backslash X$ is compact.

^aDo not confuse the notation with the commonly used notation \setminus for the difference of sets!

Example 7.21. \mathbb{Z}^n acts cocompactly on \mathbb{E}^n by translations, $b \cdot x = x + b$ for all $b \in \mathbb{Z}^n$ and all $x \in \mathbb{E}^n$. The quotient space $\mathbb{Z}^n \backslash \mathbb{E}^n$ is an n -torus.

The action of a group G on a metric space X is *proper* if for all compact subsets $K \subset X$

$$\{g \in G : K \cap g \cdot K \neq \emptyset\}$$

is finite.

Lemma 7.22. Let (X, d) be a proper metric space and let G be a group that acts on X properly by isometries. Let $\pi: X \rightarrow G \backslash X$ be the canonical projection. The expression

$$\bar{d}(x, y) = \min \{d(\tilde{x}, \tilde{y}) : \pi(\tilde{x}) = x, \pi(\tilde{y}) = y\}$$

defines a metric on $G \backslash X$.

Proof. Exercise. □

Let (X, d) be a metric space and let G be a group that acts on X properly by isometries. the metric \bar{d} on $G \backslash X$ defined in Lemma 7.22 is the *quotient metric*.

For compact subsets $A, B \subset X$ let

$$d(A, B) = \min\{d(a, b) : a \in A, b \in B\}.$$

Recall that $d(A, B) > 0$ if the compact sets A and B are disjoint.

Theorem 7.23 (Švarc, Milnor). *Let X be a proper geodesic space and let G be a group that acts on X cocompactly and properly by isometries. Then G is finitely generated and the mapping $G \xrightarrow{\Phi} X, g \mapsto g \cdot x_0$, is a quasi-isometry for any $x_0 \in X$.*

Proof. Let $R < \infty$ be the diameter of the compact metric space $G \backslash X$. Let $x_0 \in X$ Let $K = \overline{B}(x_0, R)$. Note that the choice of K implies that

$$X = \bigcup_{g \in G} g \cdot K. \quad (7.8)$$

Let $e \in G$ be the identity and let

$$S = \{g \in G : g \cdot K \cap K \neq \emptyset\} - \{e\}.$$

The set S is finite because we assume that the action of G is proper. If $x \in s \cdot K \cap K$, then $s^{-1} \cdot x \in s^{-1}K \cap K$, and therefore $s \in S$ if and only if $s^{-1} \in S$.

Let us show that S is a generating set of G .

As K is compact and G acts properly, the number

$$r = \min \{d(K, g \cdot K) : g \in G - (S \cup \{e\})\} \quad (7.9)$$

is positive.³ Let $g \in G - (S \cup \{e\})$. Let $[x_0, g \cdot x_0]$ be a geodesic segment and choose points $x_1, x_2, \dots, x_k = g \cdot x_0 \in [x_0, g \cdot x_0]$ such that $d(x_{j-1}, x_j) < r$ for all $1 \leq j \leq k$. Using (7.8), we can choose $g_0 = e, g_1, \dots, g_k \in G$ such that $d(x_i, g_i \cdot x_0) \leq R$. See Figure 7.5.

Let $s_i = g_{i-1}^{-1}g_i$ for all $1 \leq i \leq k$. As $g_i^{-1} \cdot x_i \in K$ by the choice of g_i for all $1 \leq i \leq k$, we have

$$d(K, s_i \cdot K) \leq d(g_{i-1}^{-1} \cdot x_{i-1}, s_i g_i^{-1} x_i) = d(x_{i-1} x_i) < r.$$

The definition of r implies that $s_i \in S$. As

$$g = g_k = s_1 s_2 \cdots s_k, \quad (7.10)$$

we see that S is a generating set of G .

Lemma 7.20 gives the estimate $d(g_1 \cdot x_0, g_2 \cdot x_0) \leq Md_S(g_1, g_2)$ for all $g_1, g_2 \in G$, so to prove that Φ is a quasi-isometry, it is enough to find an inequality in the reverse direction. Again, it suffices to bound $d_S(e, g)$ by $d(x_0, g \cdot x_0)$ for all $g \in G$. We may assume that the points $x_1, x_2, \dots, x_k = g \cdot x_0 \in [x_0, g \cdot x_0]$ are chosen so that $d(x_{i-1}, x_i) < R$ for all $1 \leq i \leq k$. Furthermore, k can be chosen to be minimal with this property, which implies the bound

$$k \leq \frac{d(x_0, g \cdot x_0)}{R} + 1.$$

Equation (7.10) now gives the desired estimate $d_S(e, g) \leq \frac{d(x_0, g \cdot x_0)}{R} + 1$. \square

³Exercise 7.12

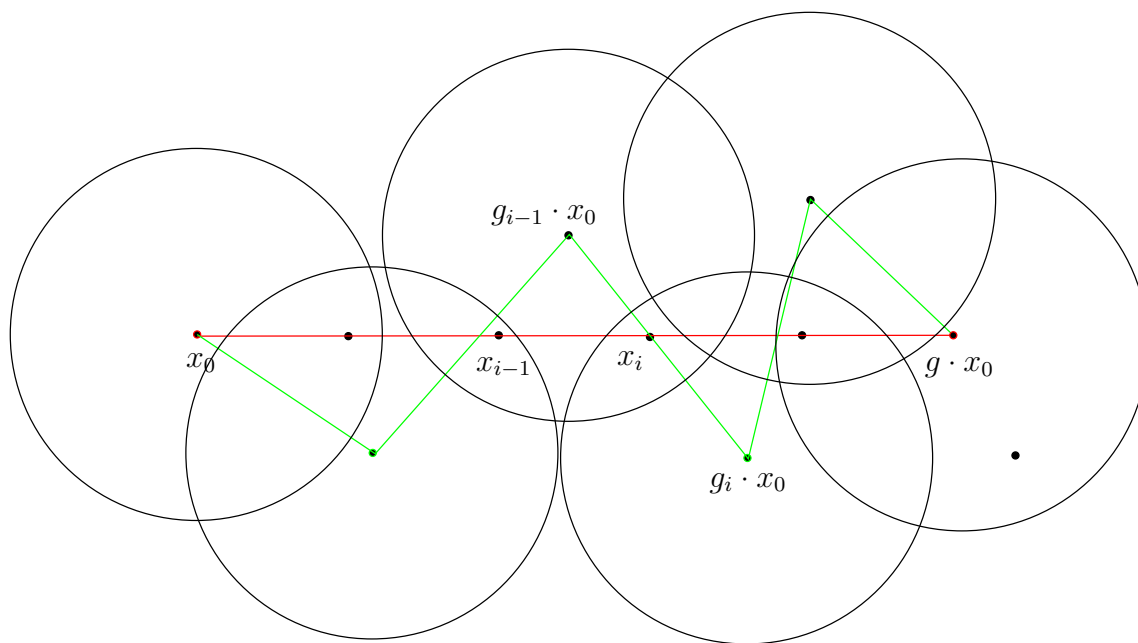

Figure 7.5 —

Example 7.24. Let $p, q, r \in \mathbb{N} - \{0, 1\}$ such that $\frac{1}{p} + \frac{1}{q} + \frac{1}{r} < 1$. Let $\Delta(p, q, r)$ be a triangle polygon in \mathbb{H}^2 with angles $\frac{\pi}{p}$, $\frac{\pi}{q}$ and $\frac{\pi}{r}$. Note that such a triangle exists by Proposition 5.10(2).

The subgroup $\Gamma_{p,q,r}$ of $\text{Isom } \mathbb{H}^2$ generated by the reflections in the sides of $\Delta(p, q, r)$ is a *hyperbolic triangle group*. It can be shown that the images under $\Gamma_{p,q,r}$ of the polygon $\Delta(p, q, r)$ tile \mathbb{H}^2 :

$$\bigcup_{g \in \Gamma_{p,q,r}} g(\Delta(p, q, r)) = \mathbb{H}^2$$

and if $g, h \in \Gamma_{p,q,r}$, $g \neq h$, then either $g(\Delta(p, q, r)) \cap (\Delta(p, q, r))$ is a side or a vertex of both triangles or $g(\Delta(p, q, r)) \cap \Delta(p, q, r) = \emptyset$. In particular, the action of $\Gamma_{p,q,r}$ on \mathbb{H}^2 is proper and cocompact. See for example [Bea, §10.6] for details. Thus, $\Gamma_{p,q,r}$ is a hyperbolic group by Proposition 7.23.

Exercises

7.1. Let X be a geodesic metric space. Let $p_1, p_2, p_3, p_4 \in X$ and let j_1, j_2 and j_3 be geodesic segments such that j_k connects p_k to p_{k+1} for all $k \in \{1, 2, 3\}$. Assume that $d(p_1, p_2) = d(p_3, p_4) = C$. Prove that $j = j_1 * j_2 * j_3: [0, d(p_2, p_3) + 2C] \rightarrow X$ is a $(1, 4C)$ -quasigeodesic segment.

7.2. Prove Lemma 7.3.

7.3. Let $F: X \rightarrow Y$ be a $(\lambda, c + 1)$ -quasi-isometric embedding. Find an upper bound on the diameter of the set $F^{-1}(y)$ for all $y \in F(X)$.

7.4. Prove Proposition 7.6.⁴

⁴Some choices need to be made.

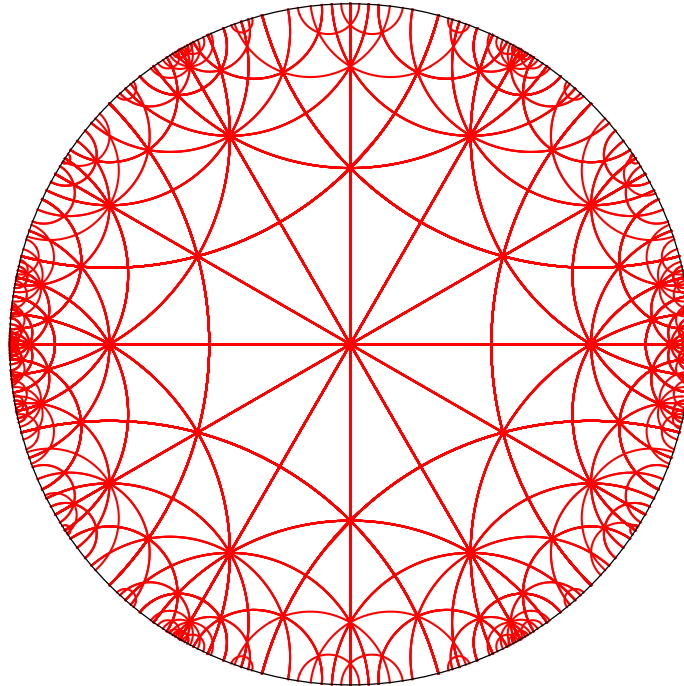

Figure 7.6 — The tiling the hyperbolic plane defined by the triangle group $\Delta(2, 4, 6)$.

- 7.5.** Prove Lemma 7.9.
- 7.6.** Prove that the mapping γ_1 in the proof of Theorem 7.10 is a $(\lambda, c+1)$ -quasi-isometric embedding.
- 7.7.** Prove Corollary 7.11.
- 7.8.** Prove that the word metric is a metric.
- 7.9.** Prove Lemma 7.14.
- 7.10.** Prove Lemma 7.16.⁵
- 7.11.** Prove Lemma 7.22.
- 7.12.** Prove that $r > 0$ in equation (7.9).
- 7.13.** Show that the bi-infinite simplicial ladder of Example 6.2(5) and Figure 6.3 is a Cayley graph of $\mathbb{Z} \times (\mathbb{Z}/2\mathbb{Z})$. Show that $\mathbb{Z} \times (\mathbb{Z}/2\mathbb{Z})$ is a hyperbolic group.⁶

⁵Note that we are assuming that the generating sets are finite.

⁶Theorem 7.8 may be useful. The hyperbolicity of the bi-infinite ladder was stated in Example 6.2(5) without a proof...

Chapter 8

Boundary at infinity

In the Poincaré ball model, hyperbolic space appears to have a boundary as a subset of \mathbb{E}^n . In chapter 5, we saw that the unit sphere \mathbb{S}^{n-1} has a geometric meaning in terms of the endpoints of geodesic lines. In this chapter, we introduce an abstract definition of the boundary at infinity of a metric space that is naturally identified as sets with the unit sphere in the Poincaré model and with $\mathbb{R}^{n-1} \times \{0\} \cup \{\infty\}$

8.1 Asymptotic rays

Let X be a metric space. The *space of geodesic rays of X* is

$$\mathcal{G}_+(X) = \{\text{geodesic rays } \rho: [0, \infty[\rightarrow X\},$$

and the *space of geodesic rays of X with origin p* is

$$\mathcal{G}_+(X, p) = \{\rho \in \mathcal{G}_+(X) : \rho(0) = p\}.$$

Two geodesic rays $\rho_1, \rho_2 \in \mathcal{G}_+(X)$ are *asymptotic*, $\rho_1 \sim \rho_2$, if

$$\sup_{t \in [0, \infty[} d(\rho_1(t), \rho_2(t)) < \infty.$$

Lemma 8.1. *Let X be a metric space. Asymptoticity is an equivalence relation in $\mathcal{G}_+(X)$.*

Proof. This is immediate from the triangle inequality. \square

Proposition 8.2. *Two geodesic rays $\rho_1, \rho_2 \in \mathcal{G}_+(\mathbb{H}^n)$ are asymptotic if and only if they have the same endpoint in the Poincaré ball model or in the upper halfspace model.*

Proof. As the inversion $F = \iota_{-e_n, 2}$ used to identify the two models in section 5.3 is a self-homeomorphism of the extended space $\widehat{\mathbb{E}}^n$, it suffices to consider the upper halfspace model.

Assume that the geodesic rays ρ_1 and ρ_2 have the same endpoint in the upper halfspace model. Using Proposition 5.17, we can assume that the common endpoint is ∞ . Now, there are $\bar{x}, \bar{y} \in \mathbb{E}^{n-1}$ and $x_n, y_n > 0$ such that $\rho_1(t) = (\bar{x}, x_n e^t)$ and $\rho_2(t) = (\bar{y}, y_n e^t)$. We can estimate the distance $d(\rho_1(t), \rho_2(t))$ ¹

$$\cosh d(\rho_1(t), \rho_2(t)) = \frac{x_n^2 + y_n^2}{2x_n y_n} + \frac{\|\bar{x} - \bar{y}\|^2}{2x_n y_n} e^{-2t} \leq \frac{x_n^2 + y_n^2}{2x_n y_n} + \frac{\|\bar{x} - \bar{y}\|^2}{2x_n y_n}$$

for all $t \geq 0$, which implies asymptoticity.

If the rays ρ_1 and ρ_2 have different endpoints in the model, we can assume that these points are ∞ and 0 . Now, ρ_1 is as above and $\max_{t \geq 0} (\rho_2)_n = M < \infty$. For large t ,

$$d(\rho_1(t), \rho_2(t)) \geq d(\rho_1(t), (\bar{x}, M)) = \log \frac{x_n}{M} + t \rightarrow \infty$$

as $t \rightarrow \infty$. This shows that the rays are not asymptotic. \square

The following characterization of asymptoticity is sometimes useful.

Proposition 8.3. *Let X be a metric space. Two geodesic rays $\rho_1, \rho_2 \in \mathcal{G}_+(X)$ are asymptotic if and only if the Hausdorff distance of their images is finite.*

Proof. It is clear that asymptotic rays are at finite Hausdorff distance from each other.

Let $\rho_1, \rho_2: \mathbb{R} \rightarrow X$ be geodesic rays and let $K > 0$ be such that $d_{\text{Haus}}(\rho_1, \rho_2) < K$. By assumption, for all $t \geq 0$, there is some $s_t \geq 0$ such that $d(\rho_1(t), \rho_2(s_t)) \leq K$. The triangle inequality gives the double inequality

$$d(\rho_1(t), \rho_1(0)) - 2K \leq d(\rho_2(s_t), \rho_2(s_0)) \leq d(\rho_1(t), \rho_1(0)) + 2K,$$

and as the mappings ρ_1 and ρ_2 are isometric embeddings,

$$t - 2K \leq |s_t - s_0| \leq t + 2K.$$

In particular, $|s_t - t| \leq s_0 + 2K$, and this implies for all $t \geq 0$ the estimate

$$d(\rho_1(t), \rho_2(t)) \leq d(\rho_1(t), \rho_2(s_t)) + d(\rho_2(s_t), \rho_2(t)) \leq K + s_0 + 2K = s_0 + 3K,$$

so the rays ρ_1 and ρ_2 are asymptotic. \square

We illustrate the use of Proposition 8.2 by an alternative proof of Proposition 8.2.

Second proof of Proposition 8.2. Assume that the geodesic rays ρ_1 and ρ_2 have the same endpoint in the upper halfspace model. Using Proposition 5.17, we can assume the endpoint is ∞ . Now, there are $\bar{x}, \bar{y} \in \mathbb{E}^{n-1}$ and $x_n, y_n > 0$ such that $\rho_1(t) = (\bar{x}, x_n e^t)$ and $\rho_2(t) = (\bar{y}, y_n e^t)$. We may assume that $x_n \leq y_n$. Using Proposition 5.9, we see that

$$\rho_2([0, \infty[) \subset \overline{\mathcal{N}}_1 \rho_1([0, \infty[) \quad \text{and} \quad \rho_1([0, \infty[) \subset \overline{\mathcal{N}}_1 \rho_2([0, \infty[),$$

which implies asymptoticity by Proposition 8.2.

The argument for rays with different endpoints is the same as in the first proof. \square

¹See equation (5.2).

In Gromov-hyperbolic spaces, the Hausdorff distance of asymptotic rays is controlled by the constant δ if we forget an initial segment of the rays. This is in strong contrast with Euclidean space where the Hausdorff distance of asymptotic geodesic rays is unbounded.

Proposition 8.4. *Let X be a δ -hyperbolic space. Let ρ_1 and ρ_2 be asymptotic geodesic rays in X .*

- (1) *If $\rho_1(0) = \rho_2(0)$, then $d(\rho_1(t), \rho_2(t)) \leq 2\delta$ for all $t \geq 0$.*
- (2) *For all large enough t , there is some $s_t \geq 0$ such that $d(\rho_1(t), \rho_2(s_t)) \leq 2\delta$.*
- (3) *For all large enough t , there is some $u \in \mathbb{R}$ such that $d(\rho_1(t), \rho_2(t - u)) \leq 6\delta$.*

Proof. Let

$$K = \sup_{t \in [0, \infty[} d(\rho_1(t), \rho_2(t)).$$

(1) The triangle with sides $\rho_1|_{[0,t]}$, $\rho_2|_{[0,t]}$ and $[\rho_1(t), \rho_2(t)]$ satisfies the Rips condition with constant δ . If $0 \leq s < t - (K + \delta)$, then $d(\rho_1(s), [\rho_1(t), \rho_2(t)]) > \delta$ by the triangle inequality. The Rips condition implies that there is some $s_2 \in [0, t]$ such that $d(\rho_1(s), \rho_2(s_2)) \leq \delta$. The triangle inequality implies that $|s - s_2| \leq \delta$.

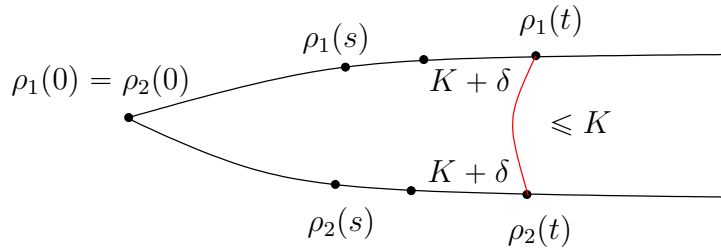

(2) Let $t > K + \delta$ and let $T > t + K + 2\delta$. As in (1), there is a point $y_t \in [\rho_2(0), \rho_1(T)]$ such that $d(\rho_1(t), y_t) \leq \delta$ and similarly, $d(y_t, \rho_2(s_t)) \leq \delta$ for some $s_t \geq 0$.

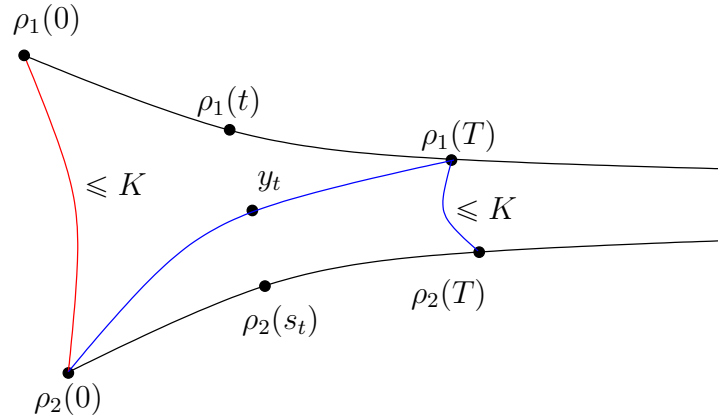

This implies the claim by the triangle inequality.

(3) Let $t_0 > K + \delta$. By (2), there is some $s_{t_0} \geq 0$ such that $d(\rho_1(t_0), \rho_2(s_{t_0})) \leq 2\delta$. Let $u = s_{t_0} - t_0$.

Note that there is some $T_0 \geq t_0$ such that $s_t > s_{t_0}$ for $t > T_0$: Assume that $s_t \leq s_{t_0}$. By assumption, $d(\rho_1(t), \rho_2(t)) \leq K$. The triangle inequality gives

$$2\delta \geq d(\rho_1(t), \rho_2(s_t)) \geq d(\rho_2(t), \rho_2(s_t)) - d(\rho_2(t), \rho_1(t)) \geq t - s_t - K \geq t - s_0 - K,$$

that implies the bound $f \leq s_{t_0} + K + 2\delta$.

Let $t > T_0$. The triangle inequality implies that

$$\begin{aligned} d(\rho_2(s_t), \rho_2(t+u)) &= |t+u-s_t| = |(t-t_0) - (s_t - (t_0+u))| \\ &= |(t-t_0) - (s_t - s_{t_0})| = |d(\rho_1(t), \rho_1(t_0)) - d(\rho_2(s_t), \rho_2(s_{t_0}))| \leq 4\delta. \end{aligned}$$

The claim follows from this estimate and (2) by the triangle inequality. \square

8.2 The boundary at infinity

Let X be a metric space. Let \sim be the asymptoticity equivalence relation on $\mathcal{G}_+(X)$. The quotient set

$$\partial_\infty X = \mathcal{G}_+(X) / \sim$$

is the *boundary at infinity*^a of X . The equivalence class of a ray ρ

$$\rho(\infty) = \{\rho' \in \mathcal{G}_+ X : \rho \sim \rho'\}$$

is its *point at infinity*.

^aThis set is also called the *space at infinity* and the *Gromov boundary* of X .

Proposition 8.2 implies that the boundary at infinity of hyperbolic space coincides with the definition we gave in section 5.3 for the Klein, Poincaré and upper halfspace models.

Lemma 8.5. *Let X be a metric space. The rule*

$$g \cdot \rho(\infty) = (g \circ \rho)(\infty)$$

for all $g \in \text{Isom}(X)$ and all $\xi = \rho(\infty)$ defines an action of $\text{Isom}(X)$ on X .

Proof. Let $\rho_1, \rho_2 \in \mathcal{G}_+(X)$. If $g \in \text{Isom}(X)$, then $d(g \circ \rho_1(t), g \circ \rho_2(t)) = d(\rho_1(t), \rho_2(t))$. Thus ρ_1 and ρ_2 are asymptotic if and only if $g \circ \rho_1$ and $g \circ \rho_2$ are asymptotic. This implies that the mapping $\rho(\infty) \mapsto g \cdot \rho(\infty)$ is well defined and a bijective selfmap of $\partial_\infty X$. The associativity of the composition of mappings implies that we have an action of $\text{Isom}(X)$. \square

Let X be a metric space. The *space of geodesic lines* of X is

$$\mathcal{G}(X) = \{\text{geodesic lines } \rho: \mathbb{R} \rightarrow X\}.$$

If $g \in \mathcal{G}(X)$, let $\rho_g^+, \rho_g^- \in \mathcal{G}_+(X)$, $\rho_g^+ = g|_{[0, \infty[}$ and $\rho_g^- : t \mapsto g(-t)$. The *endpoints (at infinity)* of g are the *negative endpoint* $g(-\infty) = \rho_g^-(\infty)$ and the *positive endpoint* $g(\infty) = \rho_g^+(\infty)$.

Example 8.6. (1) For any $S \in \mathbb{R}$, let $T_S: \mathbb{R} \rightarrow \mathbb{R}$ be the translation $T_S(t) = t + S$. If $g \in \mathcal{G}(X)$, then $g \circ T_S \in \mathcal{G}(X)$ and $g \circ T_S(\pm\infty) = g(\pm\infty)$ for all $S \in \mathbb{R}$.

(2) In chapter 5, we saw that for any $\xi_1, \xi_2 \in \partial_\infty \mathbb{H}^n$, $\xi_1 \neq \xi_2$, there is a unique geodesic line in \mathbb{H}^n with endpoints ξ_1 and ξ_2 .

(3) In \mathbb{E}^2 , every geodesic line has infinitely many geodesic lines with equal endpoints at infinity and disjoint images. On the other hand, if $g_1, g_2 \in \mathcal{G}(\mathbb{E}^2)$ with $g_1(\infty) = g_2(\infty)$, then $g_1(-\infty) = g_2(-\infty)$.

Let X be a metric space and let $\xi_1, \xi_2 \in \partial_\infty X$. If there is a geodesic line $g \in \mathcal{G}(X)$ with $g(-\infty) = \xi_1$ and $g(\infty) = \xi_2$ that is unique up to translation of the domain of definition \mathbb{R} ,^a let

$$] \xi_1, \xi_2 [= g(\mathbb{R}).$$

^aas in Example 8.6(1)

Lemma 8.7. *Let X be a metric space and let $\xi_1, \xi_2 \in \partial_\infty X$. Let $g \in \text{Isom}(X)$. Then $g(] \xi_1, \xi_2 [) =] g \cdot \xi_1, g \cdot \xi_2 [$.*

Proof. Exercise. □

8.3 The boundary at infinity of a simplicial tree

In this section, let X be an \mathbb{R} -tree and let $p \in X$.

Lemma 8.8. *Let X be an \mathbb{R} -tree and let $\rho_1, \rho_2 \in \mathcal{G}_+(X)$. Then ρ_1 and ρ_2 are asymptotic if and only if there are constants T_1, T_2 such that $\rho_1(t) = \rho_2(t + T_2)$ for all $t \geq T_1$.*

Proof. Let

$$T_0 = \sup \{ t \in]0, \infty [: \rho_1(t) \in \rho_2(]0, \infty [) \}.$$

If $T_0 < \infty$, then

$$d(\rho_1(t), \rho_2(]0, \infty [)) \geq t - T_0 \rightarrow \infty$$

as $t \rightarrow \infty$. Thus, in this case, the rays ρ_1 and ρ_2 are not asymptotic.

If $T_0 = \infty$, then let

$$T_1 = \min \{ t \in]0, \infty [: \rho_1(t) \in \rho_2(]0, \infty [) \},$$

and let $T_2' \geq 0$ such that $\rho_1(T_1) = \rho_2(T_2')$. Then, $\rho_1(t) = \rho_2(t - T_1 + T_2')$ for all $t \geq T_1$. □

Lemma 8.9. *Let X be an \mathbb{R} -tree and let $p \in X$. For all $\rho \in \mathcal{G}_+(X)$, there is a unique ray $\rho_p \in \mathcal{G}_+(X, p)$ such that $\rho_p(\infty) = \rho(\infty)$.*

Proof. Let $\rho(T) \in \rho(]0, \infty [)$ be the closest point to p . The path $\rho_p = [p, \rho(T)] * \rho|_{[T, \infty [}$ is a geodesic ray because X is an \mathbb{R} -tree, and clearly $\rho_p(\infty) = \rho(\infty)$. Uniqueness follows from Lemma 8.8. □

Lemma 8.10. *Let X be an \mathbb{R} -tree and let $p \in X$ and $\xi_1, \xi_2 \in \partial_\infty X$, $\xi_1 \neq \xi_2$. There is a unique geodesic line in $g \in \mathcal{G}(X)$ with endpoints $g(-\infty) = \xi_1$ and $g(\infty) = \xi_2$ such that $g(0)$ is the closest point to p in $g(\mathbb{R})$.*

Proof. Exercise. □

We saw in Exercise 6.2 that the limit $\lim_{t \rightarrow \infty} (\rho_1(t) \mid \rho_2(t))_p$ exists for any $\rho_1, \rho_2 \in \mathcal{G}_+(X, p)$, $\rho_1 \neq \rho_2$, if X is an \mathbb{R} -tree, and in fact,

$$\lim_{t \rightarrow \infty} (\rho_1(t) \mid \rho_2(t))_p = d(p,]\rho_1(\infty), \rho_2(\infty)[)$$

for any such pair of rays.

Let X be an \mathbb{R} -tree, let $p \in X$ and let $\xi_1, \xi_2 \in \partial_\infty X$. The *Gromov product* of ξ_1 and ξ_2 with respect to p is

$$(\xi_1 \mid \xi_2)_x = d(p,]\xi_1, \xi_2[)$$

if $\xi_1 \neq \xi_2$ and $(\xi \mid \xi)_x = \infty$ for all $\xi \in \partial_\infty X$.

Let $X \neq \emptyset$. A function $d: X \times X \rightarrow [0, \infty[$ is an *ultrametric* in X if

- (1) $d(x, x) = 0$ for all $x \in X$ and $d(x, y) > 0$ if $x \neq y$,
- (2) $d(x, y) = d(y, x)$ for all $x, y \in X$, and
- (3) $d(x, y) \leq \max(d(x, z), d(z, y))$ for all $x, y, z \in X$ (the *ultrametric inequality*).

The pair (X, d) is a *ultrametric space*.

Lemma 8.11. *Let X be an \mathbb{R} -tree and let $p \in VX$. The expression*

$$d_p(\xi_1, \xi_2) = e^{-(\xi_1 \mid \xi_2)_p}$$

*is an ultrametric in ∂X .*²

Proof. Exercise. □

A metric space is *perfect* if it has no isolated points. It is *totally disconnected* if its connected subsets are sets with one point.

Proposition 8.12. *Let X be a simplicial tree such that the degree of each vertex is at least 3, and let $p \in VX$.*

- (1) *The metric space $(\partial_\infty X, d_p)$ is perfect and totally disconnected.*
- (2) *If the degree of each vertex is bounded, then $(\partial_\infty X, d_p)$ is compact.*

Proof. Any ultrametric space with more than one point is totally disconnected because all open balls are closed.

Let $\xi \in \partial_\infty X$, and let $\rho \in \mathcal{G}_+(X, p)$ with $\rho(\infty) = \xi$. By assumption, for each $n \in \mathbb{N}$, there is a ray $\rho_n \in \mathcal{G}_+(X, p)$ such that ρ and ρ_n coincide exactly on the interval $[0, n]$. Thus,

$$d_p(\xi, \rho_n(\infty)) = d_p(\rho(\infty), \rho_n(\infty)) = e^{-n} \rightarrow 0$$

as $n \rightarrow \infty$, and $(\partial_\infty X, d_p)$ is perfect.

(2) Exercise. □

²We use the convention $e^{-\infty} = 0$. It is not essential to take p to be a vertex, it could be any point in the tree.

Corollary 8.13. *Let X be a simplicial tree such that the degree of each vertex is finite and at least 3, and let $p \in X$. The metric space $(\partial_\infty X, d_p)$ is homeomorphic to the Cantor $\frac{1}{3}$ -set.*

Proof. Every nonempty, compact, perfect, totally disconnected metric space is homeomorphic to the Cantor set, see [HY, Cor. 2-98]. \square

The following result shows that the metrics in the boundary of an \mathbb{R} -tree depend on the basepoint in a controlled manner:

Proposition 8.14. *Let X be an \mathbb{R} -tree and let $p, q \in X$. The metrics d_p and d_q are equivalent.*

Proof. The triangle inequality gives for any $\xi_1, \xi_2 \in \partial_\infty X$

$$d(q,]\xi_1, \xi_2[) - d(p, q) \leq d(p,]\xi_1, \xi_2[) \leq d(q,]\xi_1, \xi_2[) + d(p, q),$$

and, consequently, the estimate

$$e^{-d(p,q)} d_q(\xi_1, \xi_2) \leq d_p(\xi_1, \xi_2) \leq e^{d(p,q)} d_q(\xi_1, \xi_2). \quad \square$$

Proposition 8.15. *Let X be an \mathbb{R} -tree and let $p \in X$. Let $g \in \text{Isom}(X)$. The mapping $\xi \mapsto g \cdot \xi$ is a biLipschitz mapping.*

Proof. Exercise. \square

Exercises

- 8.1. Determine the boundary at infinity of the bi-infinite ladder.
- 8.2. Prove Lemma 8.7.
- 8.3. Prove Lemma 8.10.
- 8.4. Prove Lemma 8.11.
- 8.5. Prove Proposition 8.12(2).
- 8.6. Prove Proposition 8.15.
- 8.7. Show that it is not possible to define a Gromov product in the boundary of the bi-infinite ladder by setting

$$(\rho_1(\infty) | \rho_2(\infty))_p = \lim_{t \rightarrow \infty} (\rho_1(t) | \rho_2(t))_p$$

for some basepoint p .

Chapter 9

Topology of the boundary at infinity

In this chapter, we study a compactification of a proper Gromov-hyperbolic space X . The compactification is constructed using generalized geodesic rays.

9.1 Generalized rays

Let X be a geodesic metric space and let $p \in X$. For each $x \in X$, there is at least one geodesic segment with endpoints p and x . In order to consider all these geodesic segments, along with all the geodesic rays starting at p , as elements of a single topological space, we introduce the space of generalized rays as a subspace of the topological space of continuous mappings $C([0, \infty[, X)$ with the topology of compact convergence.¹

Let X be a metric space. A mapping $\omega: [0, \infty[\rightarrow X$ is a *generalized geodesic ray* if ω is a geodesic ray or there is some $m \geq 0$ such that $\omega|_{[0, m]}$ is a geodesic segment^a and $\omega(t) = \omega(m)$ for all $t \in [m, \infty[$.

The *space of generalized geodesic rays of X* is

$$\check{\mathcal{G}}_+(X) = \{\text{generalized geodesic rays } \omega: [0, \infty[\rightarrow X\} \subset C([0, \infty[, X)$$

and the *space of generalized geodesic rays of X with origin p* is

$$\check{\mathcal{G}}_+(X, p) = \{\omega \in \check{\mathcal{G}}_+(X) : \omega(0) = p\} \subset \check{\mathcal{G}}_+(X).$$

If $\sigma: [0, b] \rightarrow X$ is a geodesic segment, the *interpretation of σ as a generalized geodesic ray* is $\check{\sigma}_+ \in \check{\mathcal{G}}_+$ such that $\check{\sigma}_+|_{[0, b]} = \sigma$ and $\check{\sigma}_+(t) = \sigma(b)$ for all $t \geq b$.

If $\sigma \in \check{\mathcal{G}}_+(X) - \mathcal{G}_+(X)$, the *endpoint* of σ is

$$\sigma(\infty) = \lim_{t \rightarrow \infty} \sigma(t).$$

^aincluding the case $m = 0$

¹See Appendix B for the definitions and basic properties of the topological space $C([0, \infty[, X)$.

Note that every generalized geodesic ray that is not a geodesic ray is obtained from a geodesic ray as the interpretation of a geodesic segment.

Lemma 9.1. *Let X be a metric space and let $p \in X$. The spaces $\check{\mathcal{G}}_+(X)$ and $\check{\mathcal{G}}_+(X, p)$ are closed subsets of $C([0, \infty[, X)$ for all $p \in X$.*

Proof. Let f be a point of accumulation² of $\check{\mathcal{G}}_+(X)$. Let $K \subset [0, \infty[$ be compact. By assumption, for each and $n \in \mathbb{N} - \{0\}$, there is an element $g_n \in B_K(f, \frac{1}{n}) \cap \check{\mathcal{G}}_+(X)$.³ By definition of $B_K(f, \frac{1}{n})$, the restrictions $g_n|_K$ converge to f uniformly on K . Exercise 9.2 implies that $f \in \check{\mathcal{G}}_+(X)$.

The other claim is proved in a similar way. \square

Theorem 9.2. *Let X be a proper metric space and let $p \in X$. The space $\check{\mathcal{G}}_+(X, p)$ is compact and limit point compact for all $p \in X$.*

Proof. Let $t \in [0, \infty[$. By definition of generalized geodesics, $\omega(t) \in \overline{B}(p, t)$ for all $\omega \in \check{\mathcal{G}}_+(X, p)$. As X is proper and $\check{\mathcal{G}}_+(X, p)$ is closed, we may apply Corollary B.4 to conclude that $\check{\mathcal{G}}_+(X, p)$ is compact.

Compactness does not imply sequential compactness in general in topological spaces. However, every infinite subset of a compact space has an accumulation point, and the argument of the proof of Lemma 9.1 implies that $\check{\mathcal{G}}_+(X, p)$ is limit point compact. \square

9.2 The boundary at infinity and rays with a fixed origin

The compactness of the space of generalized rays allows us to use sequences of generalized rays that converge uniformly on compact sets to prove various existence results. We begin with the observation that in a proper Gromov-hyperbolic space, each asymptoticity class of geodesic rays can be represented by rays with a prescribed origin.

Proposition 9.3. *Let X be a proper Gromov-hyperbolic space and let $q \in X$. For any $\rho \in \mathcal{G}_+X$, there is a ray $\rho_q \in \mathcal{G}_+(X)$ with $\rho_q(0) = q$ and $\rho_q(\infty) = \rho(\infty)$.*

Proof. Let X be δ -hyperbolic. Let $\sigma_n: \underline{I}_n \rightarrow X$ be a geodesic segment with endpoints q and $\rho(n)$ for all $n \in \mathbb{N}$. The sequence $(\sigma_n)_+$ has a convergent subsequence by Theorem 9.3. The limit is a geodesic ray because $d(q, \rho(n)) \rightarrow \infty$ as $n \rightarrow \infty$.

Let us now prove that $\rho_q(\infty) = \rho(\infty)$. Let $[q, \rho(0)]$ be a geodesic segment. Let $t > 2(d(\rho(0), q) + \delta) = m$. The triangle inequality implies that $d(\rho(t), x) > \delta$ for all $x \in [q, \rho(0)]$. Let $s \geq m$. Uniform convergence on compact sets and the Rips condition on the triangle with sides $[q, \rho(0)]$, $\rho([0, M])$ and $\sigma_M(I_M)$ imply that for some integer $M > s$,

$$d(\rho(s), \rho_q([0, \infty[)) \leq d(\rho(s), \widetilde{(\sigma_M)_+}([0, \infty[)) + 1 \leq \delta + 1.$$

Thus, the image of ρ is contained in the closed $m + \delta + 2$ -neighbourhood of the image of ρ_q . Similarly, the image of ρ_q is contained in a neighbourhood of the image of ρ . \square

²Sometimes these points are called *limit points* as in [Mun] or *cluster points*.

³See Appendix B.1 for the definition of $B_K(f, \frac{1}{n})$.

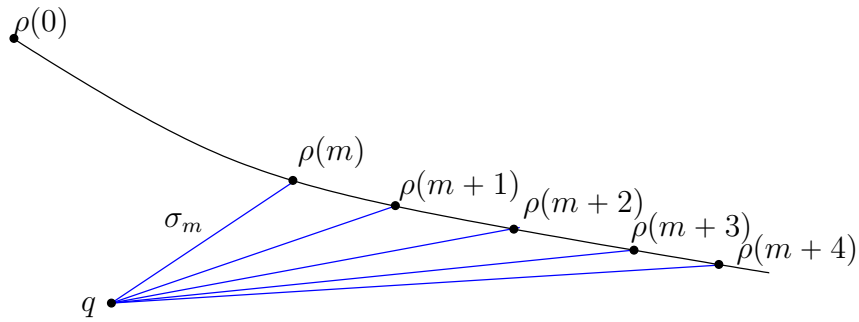

Figure 9.1 —

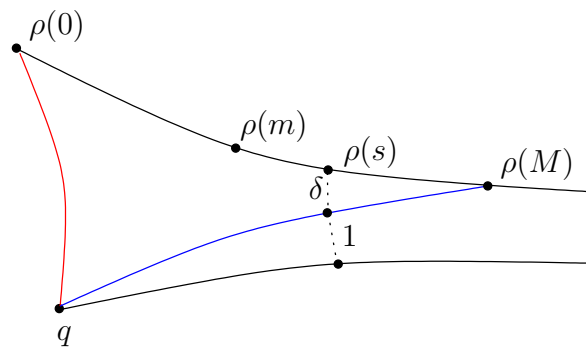

Figure 9.2 — The construction of a geodesic ray with prescribed endpoints.

Corollary 9.4. *Let X be a proper Gromov-hyperbolic space and let $p \in X$. The boundary at infinity $\partial_\infty X$ is naturally identified with $\mathcal{G}_+(X, p)/\sim$.*

Proof. The construction $\rho \mapsto \rho_p$ for any ray $\rho \in \check{\mathcal{G}}_+(X)$ described in Proposition 9.3 induces a bijection $\mathcal{G}_+(X)/\sim \rightarrow \mathcal{G}_+(X, p)/\sim$. □

9.3 Visibility

Eberlein and O’Neill [EO] introduced the following class of spaces as a generalization of simply connected negatively curved Riemannian manifolds.

A geodesic metric space X is a *visibility space* if for any two $\xi_-, \xi_+ \in \partial_\infty X$, with $\xi_- \neq \xi_+$, there is a geodesic line $g \in \mathcal{G}(X)$ with $g(-\infty) = \xi_-$ and $g(\infty) = \xi_+$.

Example 9.5. (1) Hyperbolic space \mathbb{H}^n is a visibility space for all $n \geq 2$ by Propositions 5.1, 5.3 and 5.7.

(2) \mathbb{R} -trees are visibility spaces by Lemma 8.10.

(3) \mathbb{E}^n is not a visibility space when $n \geq 2$: If geodesic lines $g_1, g_2 \in \mathcal{G}(\mathbb{E}^n)$ are parallel, the lines $t \mapsto g_1(-t)$ and $t \mapsto g_2(-t)$ are parallel. Thus, given $\xi \in \partial_\infty \mathbb{E}^n$, there is a unique $\xi' \in \partial_\infty \mathbb{E}^n$ such that there is a geodesic line with endpoints ξ and ξ' .

In order to prove that proper Gromov-hyperbolic spaces are visibility spaces, we introduce generalized geodesic lines analogously with the generalized geodesic rays defined in section 9.1.

Let X be a metric space. A continuous mapping $\omega: \mathbb{R} \rightarrow X$ is a *generalized geodesic line* if ω is a geodesic line or there is some closed^a interval $I \subset \mathbb{R}$ such that $\omega|_I$ is an isometric embedding and ω is locally constant in the complement of I .

The *space of generalized geodesic lines of X* is

$$\check{\mathcal{G}}(X) = \{\text{generalized geodesic lines } \omega: \mathbb{E}^1 \rightarrow X\} \subset C(\mathbb{E}^1, X).$$

If I is a closed interval and $\sigma: I \rightarrow X$ is a geodesic segment or a generalized geodesic ray, let $\check{\sigma} \in \check{\mathcal{G}}$ such that $\check{\sigma}|_I = \sigma$ and $\check{\sigma}$ is locally constant in $\mathbb{R} - I$.

^anot necessarily bounded

Lemma 9.6. *Let X be a metric space. The space $\check{\mathcal{G}}(X)$ is a closed subset of $C(\mathbb{E}^1, X)$.*

Proof. Similar to the proof of Theorem 9.1, exercise. □

Theorem 9.7. *Let X be a proper metric space and let $K \subset X$ be compact. The space $\{g \in \check{\mathcal{G}}(X) : g(0) \in K\}$ is compact.*

Proof. Similar to the proof of Theorem 9.2, exercise. □

Theorem 9.8. *Proper Gromov-hyperbolic spaces are visibility spaces.*

Proof. Let X be a proper δ -hyperbolic space. Let $p \in X$ and let $\rho_1, \rho_2 \in \mathcal{G}_+(X, p)$ with $\rho_1(\infty) \neq \rho_2(\infty)$. As the rays ρ_1 and ρ_2 are not asymptotic, there is some $T > 0$ for which $\min\{d(\rho_1(T), \rho_2(t)) : t \geq 0\} \geq \delta$.

For $n \in \mathbb{N}$, let $\sigma_n^0: [0, b_n] \rightarrow X$ be a geodesic segment with endpoints $\sigma_n^0(0) = \rho_1(n)$ and $\sigma_n^0(b_n) = \rho_2(n)$. The Rips condition implies that for each $n \in \mathbb{N}$ such that $n \geq T$, there is some $t_n \in [0, b_n]$ such that $p_n = \sigma_n^0(t_n) \in \overline{B}(\rho_1(T), \delta)$.

We reparametrize the geodesic segments σ_n^0 as the mappings $\sigma_n: [-t_n, b_n - t_n] \rightarrow X$, $\sigma_n(t) = \sigma_n^0(t + t_n)$ for all $n \geq T$. Theorem 9.7 implies that the sequence $(\sigma_n)_{j \in \mathbb{N}}$ has a convergent subsequence and the limit is a geodesic line g .

By the Rips condition, the Hausdorff distance of $\sigma_n(I_n)$ to $\rho_1([0, n[) \cup \rho_2([0, n[)$ is at most δ . Thus, the same holds for the image of g . But this implies that $g(-\infty) = \xi_1$ and $g(\infty) = \xi_2$. □

9.4 Quasi-isometries and the boundary at infinity

In this section we use quasigeodesic rays that were introduced in section 7.1 to study the behaviour of the boundary at infinity under quasi-isometric embeddings and quasi-isometries. We begin by introducing convenient notation in analogy with that used for geodesic rays.

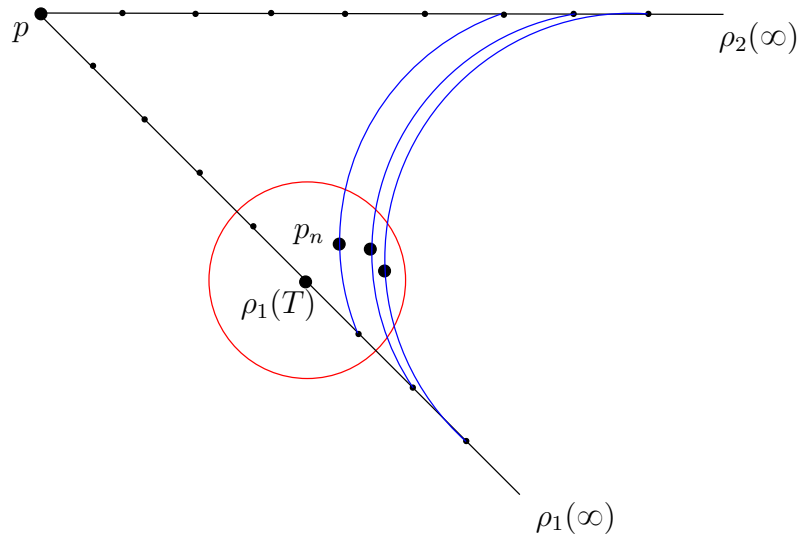

Figure 9.3 — The construction of a geodesic line with prescribed endpoints.

Let X be a metric space. The set of quasigeodesic rays of X is

$$\mathcal{Q}\mathcal{G}_+(X) = \{\text{quasigeodesic rays } \rho: [0, \infty[\rightarrow X\},$$

and the set of quasigeodesic rays of X with origin p is

$$\mathcal{Q}\mathcal{G}_+(X, p) = \{\rho \in \mathcal{Q}\mathcal{G}_+(X) : \rho(0) = p\}.$$

Two quasigeodesic rays $\rho_1, \rho_2 \in \mathcal{G}_+(X)$ are *asymptotic*, $\rho_1 \sim \rho_2$, if the Hausdorff distance of their images is finite. The equivalence class $\rho(\infty)$ of a quasigeodesic ray ρ is its *point at infinity*.

The following result allows us to represent the boundary at infinity using quasirays instead of geodesic rays.

Proposition 9.9. *Let X be a proper Gromov-hyperbolic space and let $q \in X$. For any $\rho \in \mathcal{Q}\mathcal{G}_+(X, q)$, there is a ray $\bar{\rho} \in \mathcal{G}_+(X, q)$ such that $\bar{\rho}(\infty) = \rho(\infty)$.*

Proof. The existence of $\bar{\rho}$ is proved in the same way as Proposition 9.3. Note that $d(\rho(0), \rho(t)) \rightarrow \infty$ as $t \rightarrow \infty$ because ρ is a quasi-isometric embedding. The asymptoticity follows from Theorem 7.10. \square

Note that Proposition 9.9 has no analog in \mathbb{E}^n , see Exercise 9.5.

Corollary 9.10. *Let X be a proper Gromov-hyperbolic space and let $p \in X$. The boundary at infinity $\partial_\infty X$ is naturally identified with $\mathcal{Q}\mathcal{G}_+(X)/\sim$ and $\mathcal{Q}\mathcal{G}_+(X, p)/\sim$.* \square

Proposition 9.11. *Let X and Y be metric spaces. Let $\rho_1, \rho_2 \in \mathcal{G}_+(X)$ and let $F: X \rightarrow Y$ be a quasi-isometric embedding. Then $\rho_1(\infty) = \rho_2(\infty)$ if and only if $F \circ \rho_1(\infty) = F \circ \rho_2(\infty)$.*

Proof. Exercise. \square

Corollary 9.12. *Let X be a metric space and let Y be a proper Gromov-hyperbolic space. A quasi-isometric embedding $F: X \rightarrow Y$ induces an injective mapping $F_\infty: \partial_\infty X \rightarrow \partial_\infty Y$. \square*

Proposition 9.13. *Let X and Y be proper Gromov-hyperbolic spaces and let $F: X \rightarrow Y$ be a quasi-isometry. The mapping $F_\infty: \partial_\infty X \rightarrow \partial_\infty Y$,*

$$F_\infty(\rho(\infty)) = (F \circ \rho)(\infty),$$

is a bijection.

Proof. Let $\bar{F}: Y \rightarrow X$ be a quasi-inverse of F and let $K \geq 0$ such that

$$d(\bar{F} \circ F(x), x) \leq K \quad \text{and} \quad d(F \circ \bar{F}(y), y) \leq K \quad (9.1)$$

for all $x \in X$ and all $y \in Y$. If $\rho \in \mathcal{G}_+(X)$, then $\bar{F} \circ F \circ \rho \in \mathcal{Q}\mathcal{G}_+(X)$, and (9.1) implies that $d(\bar{F} \circ F \circ \rho(t), \rho(t)) \leq K$ for all $t \in [0, \infty[$. Thus

$$\bar{F}_\infty \circ F_\infty(\rho(\infty)) = \bar{F} \circ F \circ \rho(\infty) = \rho(\infty).$$

An analogous argument gives $F_\infty \circ \bar{F}_\infty = \text{id}$, so F_∞ is a bijection. \square

Example 9.14. The boundary at infinity of the bi-infinite ladder is naturally identified with $\partial_\infty \mathbb{E}^1 = \{-\infty, \infty\}$ because these two spaces are quasi-isometric by Proposition 7.6.

9.5 A topology on $X \cup \partial_\infty X$

In this section, we define a topology in the union of a proper Gromov-hyperbolic space X and its boundary at infinity, and obtain a geometrically natural compactification of X .

Let X be a metric space and let $p \in X$. The mapping $E: \check{\mathcal{G}}_+(X, p) \rightarrow X \cup \partial_\infty X$, $E(\rho) = \rho(\infty)$, is the *endpoint map*.

Proposition 9.15. *The restriction of the endpoint map $E: \check{\mathcal{G}}_+(X, p) - \mathcal{G}_+(X, p) \rightarrow X$ is a quotient map.*

Proof. Let $A \subset X$ be closed. Let $g_n \in E^{-1}(A)$ such that $g_n \rightarrow g$ as $n \rightarrow \infty$. Then $g_n(\infty) \in A$ for all $n \in \mathbb{N}$ and $g(\infty) = \lim_{n \rightarrow \infty} g_n(\infty) \in A$ as A is closed. Thus, $g \in E^{-1}(A)$, so E is continuous.

Let $A \subset X$ such that $E^{-1}(A)$ is closed. Let $a_k \in A$ be a sequence that converges in X . Let $g_k \in E^{-1}(A)$ such that $g_k(\infty) = a_k$ for all $k \in \mathbb{N}$. This sequence has a convergent subsequence $g_{n_k} \rightarrow g \in E^{-1}(A)$ as $k \rightarrow \infty$ by Theorem 9.2, and $a_{n_k} = g_{n_k}(\infty) \rightarrow g(\infty) \in A$. Thus, A is closed. \square

Let \sim_E be the equivalence relation in $\check{\mathcal{G}}_+(X, p)$ defined by $g \sim_E g'$ if and only if $g(\infty) = g'(\infty)$.

Corollary 9.16. *X is homeomorphic with $(\check{\mathcal{G}}_+(X, p) - \mathcal{G}_+(X, p)) / \sim_E$.*

Proof. The claim follows from Proposition 9.15 by Proposition B.7. □

The topology (based at p) of $X \cup \partial_\infty X$ is the quotient topology of the topology of compact convergence on $\check{\mathcal{G}}_+(X, p)$.

Theorem 9.17. *Let X be a proper Gromov-hyperbolic space. The space $X \cup \partial_\infty X$ is compact and X is open and dense in $X \cup \partial_\infty X$.*

Proof. The quotient map from $\check{\mathcal{G}}_+(X)$ to $\check{\mathcal{G}}_+(X)/\sim_E$ is continuous and $\check{\mathcal{G}}_+(X)$ is compact by Theorem 9.2, and the image of a compact space under a continuous mapping is compact.

Corollary 9.16 implies that X is open in $X \cup \partial_\infty X$. If $\xi \in \partial_\infty X$, then $\xi = \rho(\infty)$ for some $\rho \in \mathcal{G}_+(X, x_0)$. The sequence $(\rho|_{[0,k]})_{k \in \mathbb{N}}$ converges to ρ . □

Example 9.18. The space $\mathbb{H}^n \cup \partial_\infty \mathbb{H}^n$ is homeomorphic to the closed unit ball in \mathbb{E}^n . Consider the Poincaré ball model. The image of the neighbourhood $B_{[0,r]}(\rho, \varepsilon)$, with $r, \varepsilon > 0$, of geodesic rays $\rho \in \mathcal{G}_+(\mathbb{H}^2, 0)$ in $\mathbb{H}^2 \cup \partial_\infty \mathbb{H}^2$ is the union of the hyperbolic ball $B(\rho(r), \varepsilon)$ and the intersection of a sector with the annulus $\{z \in \mathbb{H}^2 : d(z, 0) > r\}$ of the unit disk as in Figure 9.4. Clearly, these neighbourhoods and the topology of \mathbb{H}^2 generate the topology of the closed unit ball.

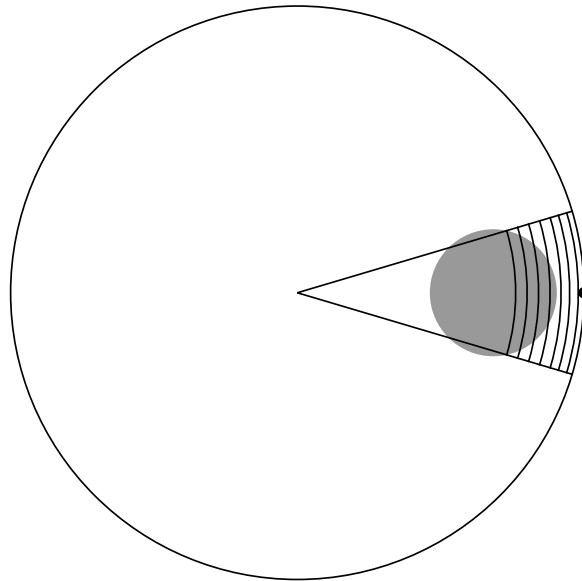

Figure 9.4 — A neighbourhood of the boundary point $1 \in \partial_\infty \mathbb{H}^2$ consists of the union of an annular sector and a ball.

Example 9.19. Let X be a regular tree with constant degree 3, and let $x_0 \in VX$. We saw in Lemma 8.9 that the boundary at infinity of X is identified with the space of geodesic rays $\mathcal{G}_+(X, x_0)$. Let $\rho \in \mathcal{G}_+(X, x_0)$, $r \in \mathbb{N}$ and $\varepsilon > 0$. As X is a tree,

$$\begin{aligned} B_{[0,r]}(\rho, \varepsilon) &= \{\rho' \in \check{\mathcal{G}}_+(X, x_0) : d(\rho(t), \rho'(t)) < \varepsilon \text{ for all } t \in [0, r]\} \\ &= \{\rho' \in \check{\mathcal{G}}_+(X, x_0) : \rho'|_{[0,r]} = \rho|_{[0,r]}\}, \end{aligned}$$

See Figure 9.5. Notice that

$$B_{[0,r]}(\rho, \varepsilon) \cap \partial_\infty X = \overline{B}(\rho(\infty), e^{-1})$$

for the metric d_{x_0} defined in section 8.3. Thus, we see that the topology defined in this section agrees with the metric topology in the boundary of X .

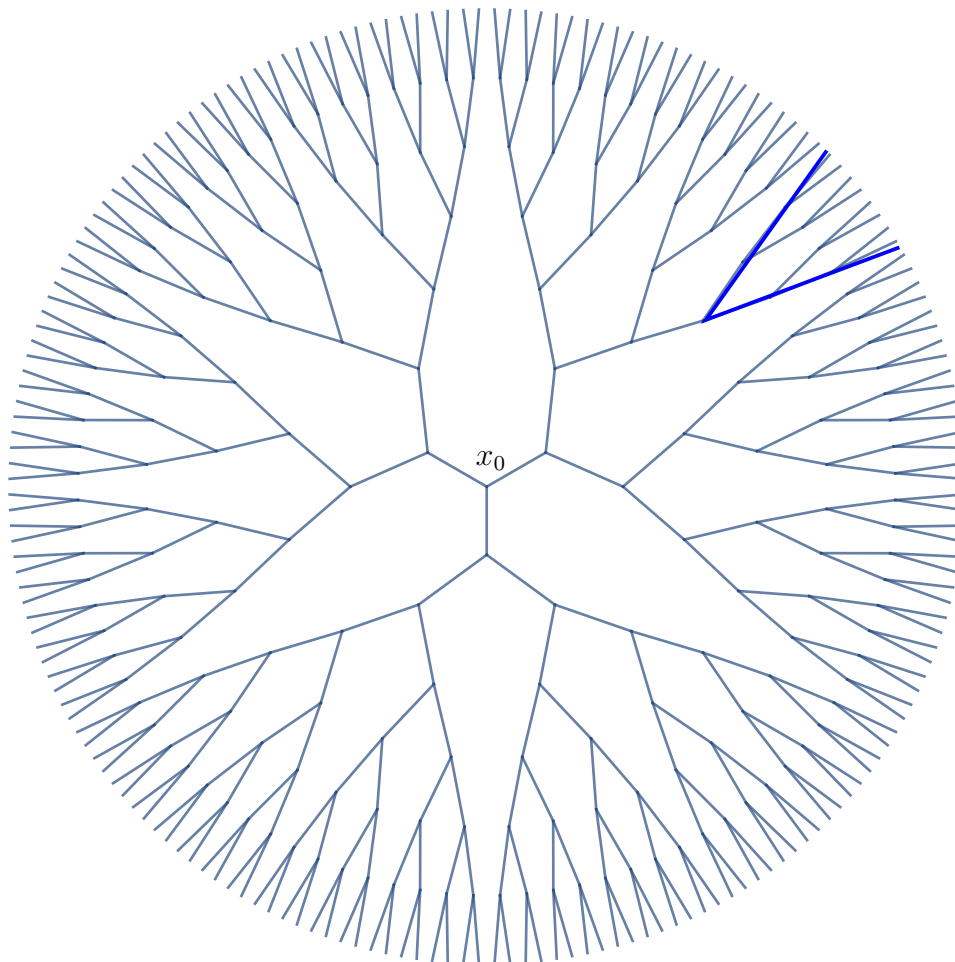

Figure 9.5 — The part of the tree bounded by the blue wedge is $B_{[0,4]}(\rho, \varepsilon)$ for any ray $\rho \in \mathcal{G}_+(X, x_0)$ that enters the wedge and a small $\varepsilon > 0$.

Exercises

9.1. Let X be a metric space, let $m > 0$ and let $j_k : [0, m] \rightarrow X$ be geodesic segments. Assume that the sequence $(j_k)_{k \in \mathbb{N}}$ converges uniformly to a mapping j . Prove that j is a geodesic segment.

9.2. Let X be a metric space and let $g_k \in \check{\mathcal{G}}_+(X)$ for all $k \in \mathbb{N}$ such that $g_k \rightarrow g$ uniformly on compact sets. Prove that $g \in \check{\mathcal{G}}_+(X)$.

9.3. Prove Lemma 9.6.

9.4. Prove Theorem 9.7.⁴

9.5. Let $\gamma: [0, \infty[\rightarrow \mathbb{E}^2$, $\gamma(t) = (t, \log(1+t))$ be a parametrization in polar coordinates (r, θ) of the *logarithmic spiral*. Prove that γ is a $(\sqrt{2}, 0)$ -quasigeodesic ray.⁵ Is there a geodesic ray in \mathbb{E}^2 asymptotic to γ ?

9.6. Prove Proposition 9.11.

⁴You may assume the result of Lemma 9.6.

⁵The length of a path is at least the distance of its endpoints.

Chapter 10

CAT(−1) spaces

In this chapter, we will begin the study of CAT(κ)-spaces that formalize the concept of metric spaces with curvature bounded above by κ with $\kappa \in \mathbb{R}$. We will then study some basic properties of CAT(0)-spaces that are *spaces of non-positive curvature*, and later concentrate on CAT(−1)-spaces as a convenient class of *spaces of negative curvature*. If $\kappa < 0$, then CAT(κ)-spaces are Gromov-hyperbolic spaces, and all the theory from chapters 6 to 9 is applicable.

10.1 Comparison geometry

If (X, d) is a metric space and $k > 0$ is a constant, then (X, kd) is a metric space. For example, $(\mathbb{S}^n, kd_{\mathbb{S}^n})$ is isometric with the sphere of radius k . In particular, $(\mathbb{S}^n, kd_{\mathbb{S}^n})$ is not isometric with \mathbb{S}^n . Similarly, it can be seen for example by considering the configuration studied in Exercise 5.2 and Figure 5.5 that the spaces $(\mathbb{H}^n, kd_{\mathbb{H}^n})$ are not isometric for different parameters $k > 0$. On the other hand the mapping $F: (\mathbb{R}^n, \|\cdot\|) \rightarrow (\mathbb{R}^n, k\|\cdot\|)$, $F(x) = \frac{1}{k}x$, is an isometry for any norm $\|\cdot\|$.

After these observations, the following family of 2-dimensional metric spaces appears reasonable.

Let $\kappa \in \mathbb{R}$. The metric space

$$\bar{X}_\kappa = \begin{cases} \mathbb{S}_\kappa^2 = (\mathbb{S}^2, \frac{1}{\sqrt{\kappa}}d_{\mathbb{S}^2}) & \text{if } \kappa > 0 \\ \mathbb{E}^2 & \text{if } \kappa = 0. \\ \mathbb{H}_\kappa^2 = (\mathbb{H}^2, \frac{1}{\sqrt{-\kappa}}d_{\mathbb{H}^2}) & \text{if } \kappa < 0 \end{cases}$$

is the *model space of curvature* κ .

With this definition, the space \bar{X}_κ is the unique 2-dimensional simply-connected Riemannian manifold of Riemannian curvature κ . In this course, we do not discuss Riemannian geometry to any depth, and refer to for example [O’N] or [Pet] and [BH, Appendix of Ch. II.1] for these topics.

In *comparison geometry*, metric spaces are compared with the model spaces defined above using the geometric properties of triangles.

Let (X, d) be metric space and let $x, y, z \in X$ be three distinct points. Let $\kappa \in \mathbb{R}$. If there are points $\bar{x}, \bar{y}, \bar{z} \in \bar{X}_\kappa$, the triangle with vertices $\bar{x}, \bar{y}, \bar{z} \in \bar{X}_\kappa$ is a *comparison triangle* of x, y, z in \bar{X}_κ .

If Δ is a triangle in X , the comparison triangle of its vertices is the *comparison triangle* of Δ .

Proposition 10.1. *Let $\kappa \in \mathbb{R}$. Let X be a metric space and let $x, y, z \in X$. The triple $\{x, y, z\}$ has a comparison triangle in \bar{X}_κ for $\kappa \leq 0$.*

Proof. As X is a metric space, the side lengths of $\Delta(x, y, z)$ satisfy the assumptions of Propositions 2.4 and 5.10. \square

Comparison triangles exist also in the spherical model spaces \bar{X}_κ for $\kappa > 0$ if the sum of the pairwise distances of the three points is at most the length of the equator of the sphere \bar{X}_κ . For simplicity, we will restrict to $\kappa \leq 0$ although the general case is important even when the main interest is in negatively curved spaces. See for example [BH, Chapter II.5].

The proof of the following lemma is based on repeated application of the cosine law in \bar{X}_κ . In \mathbb{H}_κ^2 , with the standard notations for triangles as in section 1.5, the cosine law takes the form

$$\cosh(\sqrt{-\kappa}c) = \cosh(\sqrt{-\kappa}a) \cosh(\sqrt{-\kappa}b) - \sinh(\sqrt{-\kappa}a) \sinh(\sqrt{-\kappa}b) \cos \gamma .$$

This cosine law follows directly from the hyperbolic cosine law of Proposition 4.10. Recall that the Euclidean cosine law was proved in Proposition 2.2.

Lemma 10.2 (Aleksandrov's lemma). *Let $\kappa \leq 0$. Let $A, B, C, D, A', B', C', D' \in \bar{X}_\kappa$ such that B and C are in different components of the complement of the line through A and D such that $d(A, B) = d(A', B')$, $d(A, C) = d(A', C')$, $d(B, D) + d(D, C) = d(B', C')$ and $D' \in [B', C']$ such that $d(B, D) = d(B', D')$. Let α, β, γ and $\eta \geq \pi$ be the interior angles in the quadrilateral with vertices A, B, C and D , and let α', β' and γ' be the interior angles of the triangle with vertices A', B' and C' . Then $\alpha' \geq \alpha$, $\beta' \geq \beta$, $\gamma' \geq \gamma$ and $d(A', D') \geq d(A, D)$.*

Proof. Let Δ' be the triangle with vertices A', B' and C' . The triangle inequality implies that $d(B, C) \leq d(B', C')$. Thus, the cosine law applied to the triangle with vertices A, B and C and to Δ' implies that $\alpha \leq \alpha'$.

Let \tilde{C} be the unique point on the geodesic line through B and D such that $d(B, \tilde{C}) = d(B, D) + d(D, C)$ and $d(D, \tilde{C}) = d(D, C)$. The angle at D of the triangle with vertices A, D and \tilde{C} , is not greater than the angle at D in the triangle with vertices A, D and C . Thus, the cosine law implies that

$$d(A, \tilde{C}) \leq d(A, C) = d(A', C') .$$

Thus, the cosine law applied to the triangle with vertices A, B and \tilde{C} and to Δ' implies that $\beta \leq \beta'$. An analogous argument shows that $\gamma \leq \gamma'$.

The cosine law applied to the triangle with vertices A, B and D and to the triangle with vertices A', B' and D' implies that $d(A, D) \leq d(A', D')$. \square

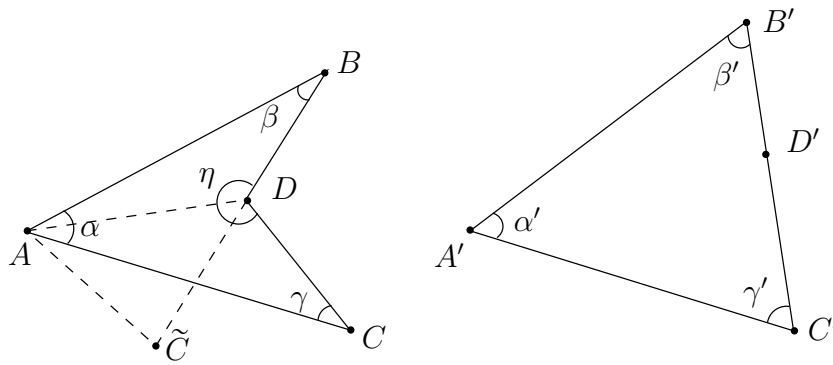

Figure 10.1 — Aleksandrov’s lemma.

Aleksandrov’s lemma is an important technical tool in many proofs in comparison geometry.

10.2 $\text{CAT}(\kappa)$ spaces

Let X be a geodesic metric space and let $\kappa \leq 0$. Let $j_i: I_i \rightarrow X$, $i \in \{1, 2, 3\}$ be geodesic segments that form a triangle Δ in X , and let $\bar{j}_i: I_i \rightarrow \bar{X}_\kappa$ be the sides of the comparison triangle $\bar{\Delta}$ of Δ such that $\bar{j}_i(0) = \bar{j}_i(1)$ for all $i \in \{1, 2, 3\}$. Then $\bar{p} = \bar{j}_i(t)$ is the *comparison point* of a point $p = j_i(t)$ for $t \in I_i$ and $i \in \{1, 2, 3\}$.

Most of the time, we suppress the notation of the geodesic segments forming a triangle using formulations such as

Let $\bar{p} \in [\bar{x}, \bar{y}]$ be the comparison point of $p \in [x, y]$

meaning that $\bar{p} \in [\bar{x}, \bar{y}]$ is the unique point with $d(\bar{x}, \bar{p}) = d(x, p)$ and $d(\bar{y}, \bar{p}) = d(y, p)$. Here, if X is not uniquely geodesic, the notation $[x, y]$ refers to one of the geodesic segments connecting x to y .

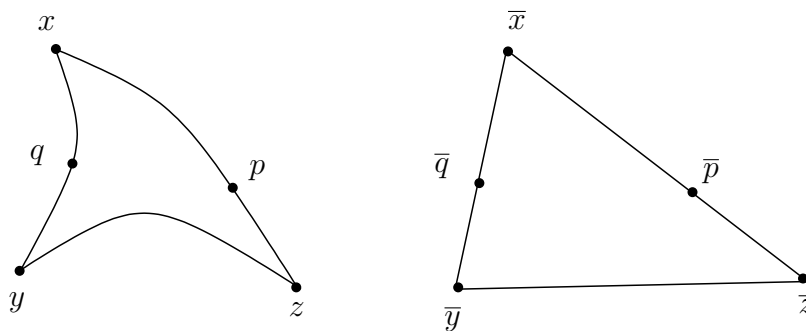

Figure 10.2 — A triangle in a metric space and its comparison triangle in $\bar{X}_0 = \mathbb{E}^2$.

Let $\kappa < 0$. A geodesic metric space X is a CAT(κ)-space^a if for all $x, y, z \in X$ and any points $p \in [x, y]$ and $q \in [x, z]$, the comparison points \bar{p} and \bar{q} satisfy $d(p, q) \leq d(\bar{p}, \bar{q})$.

^aThe letters CAT refer to E. Cartan, A. D. Aleksandrov and V. A. Toponogov who studied similar conditions for curvature.

It is, in fact, sufficient to check the defining inequality in the case that one of the points is a vertex of the triangle:

Proposition 10.3. *Let X be a geodesic metric space and let $\kappa \leq 0$. Then X is a CAT(κ)-space if and only if for all $x, y, z \in X$ and $p \in [y, z]$, $d(x, p) \leq d(\bar{x}, \bar{p})$.*

Proof. Exercise. □

Example 10.4. (1) \mathbb{H}^n is a CAT(-1)-space.

(2) \mathbb{R} -trees are CAT(κ)-spaces for all $\kappa \leq 0$: Let X be an \mathbb{R} -tree and let $x, y, z \in X$. Let $\bar{x}, \bar{y}, \bar{z} \in \mathbb{H}^2$ be the vertices of a comparison triangle. Let $\gamma: [0, d(y, z)] \rightarrow X$ be the unique geodesic segment with $\gamma(0) = y$ and $\gamma(d(y, z)) = z$. If $0 \leq t \leq (x|z)_y$, then

$$d(\gamma(t), x) = d(y, x) - t \leq d(\bar{\gamma}(t), \bar{x})$$

because the distance $d(\gamma(t), x)$ decreases at maximal speed for any geodesic in any geodesic metric space. The claim for $(x|z)_y \leq t \leq d(y, z)$ is checked in the same way.

Lemma 10.5. *Let $\kappa_1 \leq \kappa_2 \leq 0$. Let $x_1, y_1, z_1 \in \bar{X}_{\kappa_1}$ and $x_2, y_2, z_2 \in \bar{X}_{\kappa_2}$ such that $d(x_1, y_1) = d(x_2, y_2)$, $d(x_1, z_1) = d(x_2, z_2)$ and $\sphericalangle_{x_1}(y_1, z_1) = \sphericalangle_{x_2}(y_2, z_2)$. Then $d(y_1, z_1) \geq d(y_2, z_2)$.*

Proof. Let us use polar coordinates (r_1, θ_1) centered at x_1 and (r_2, θ_2) centered at x_2 . In polar coordinates, the Riemannian metric of \bar{X}_κ has the expression

$$ds^2 = dr^2 + \frac{1}{\sqrt{-\kappa}} \sinh^2(\sqrt{-\kappa}r) d\theta^2 = dr^2 + f(\kappa, r)^2 d\theta^2,$$

and if $\kappa = 0$, we have the Euclidean plane with the Riemannian metric $ds^2 = dr^2 + r^2 d\theta^2$, and we set $f(0, r) = r$.

For fixed $r > 0$, the mapping $\kappa \mapsto f(\kappa, r)$ is strictly decreasing. Therefore, the mapping $(r_1, \theta_1) \mapsto (r_2, \theta_2)$ strictly decreases the length of each tangent vector that is not radial. Thus, $d(y_1, z_1) \geq d(y_2, z_2)$. □

Lemma 10.6. *Let $\kappa_1 \leq \kappa_2 \leq 0$. Let $x_1, y_1, z_1 \in \bar{X}_{\kappa_1}$ and $x_2, y_2, z_2 \in \bar{X}_{\kappa_2}$ such that $d(x_1, y_1) = d(x_2, y_2)$, $d(x_1, z_1) = d(x_2, z_2)$ and $d(y_1, z_1) = d(y_2, z_2)$. Then the angles of the triangle with vertices x_1, y_1 and z_1 are not greater than the corresponding angles of the triangle with vertices x_2, y_2 and z_2 .*

Proof. This is an immediate consequence of Lemma 10.5. □

Lemma 10.7. *Let $\kappa_1 \leq \kappa_2 \leq 0$. Then \bar{X}_{κ_1} is a CAT(κ_2)-space.*

Proof. Let $x_1, y_1, z_1 \in \overline{X}_{\kappa_1}$ and $x_2, y_2, z_2 \in \overline{X}_{\kappa_2}$ such that $d(x_1, y_1) = d(x_2, y_2)$, $d(x_1, z_1) = d(x_2, z_2)$ and $d(y_1, z_1) = d(y_2, z_2)$. Let $p_1 \in [y_1, z_1]$ and let p_2 be its comparison point in $[y_2, z_2]$.

Let $\overline{x}_1, \overline{y}_1, \overline{z}_1, \overline{p}_1 \in \overline{X}_{\kappa_2}$ such that the triangles with vertices $\overline{x}_1, \overline{y}_1, \overline{p}_1$ and $\overline{x}_1, \overline{z}_1, \overline{p}_1$ are comparison triangles of the triangles with vertices x_1, y_1, p_1 and x_1, z_1, p_1 and the points \overline{y}_1 and \overline{z}_1 are in different components of the complement of the geodesic line through the points \overline{x}_1 and \overline{p}_1 .

Let γ and γ' be the angles at p_1 of the triangles with vertices x_1, p_1 and z_1 and with vertices x_1, p_1 and y_1 , respectively. Lemma 10.6 implies that $\overline{\gamma}_1 \geq \gamma_1$ and $\overline{\gamma}'_1 \geq \gamma'_1$. In particular, $\overline{\gamma}_1 + \overline{\gamma}'_1 \geq \pi$, and we may apply Aleksandrov's lemma¹ to the quadrilateral with vertices $\overline{x}_1, \overline{y}_1, \overline{p}_1$ and \overline{z}_1 and to the triangle with vertices x_2, y_2 and z_2 to conclude that $d(x_1, p_1) = d(\overline{x}_1, \overline{p}_1) \leq d(x_2, p_2)$. Thus, \overline{X}_{κ_1} is a CAT(κ_2)-space by Proposition 10.3. \square

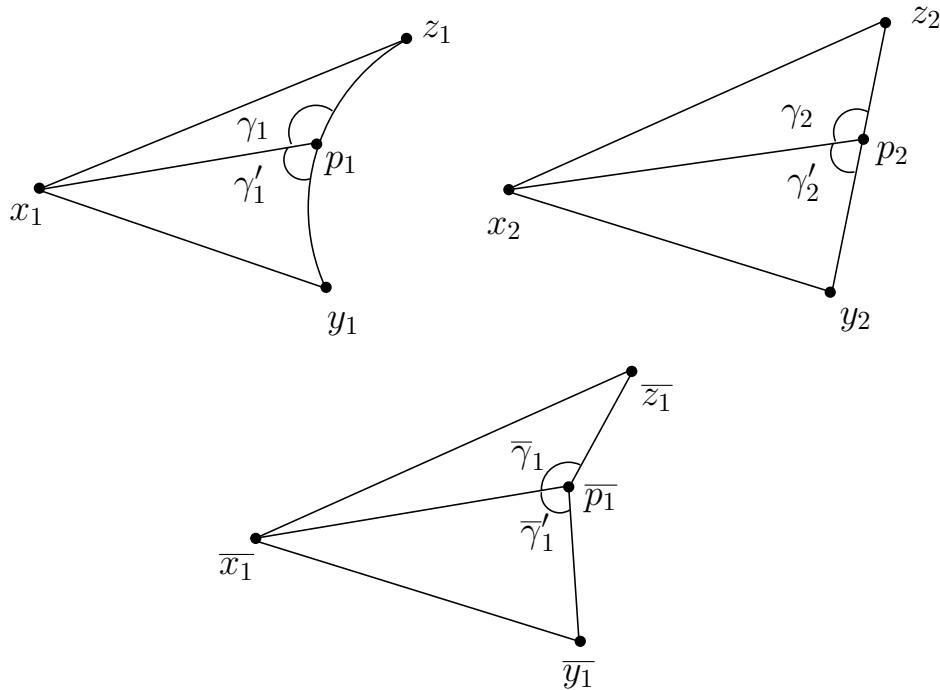

Figure 10.3 — The triangles in the proof of Lemma 10.7.

It follows from Lemma 10.7 that the classes of CAT(κ)-spaces are naturally nested in terms of the real parameter κ .

Proposition 10.8. *If $\kappa < \kappa' \leq 0$ and X is a CAT(κ) space, then X is a CAT(κ') space.*

Proof. This is a consequence of Lemma 10.7. \square

As the metric of \overline{X}_{κ} for κ is obtained from that of the hyperbolic plane by multiplying with the factor $\frac{1}{\sqrt{-\kappa}}$, it is sufficient to concentrate on (locally) CAT(-1) spaces when we study negatively curved spaces. In many cases, it is sufficient to only assume that the space is a CAT(0)-space.

¹Lemma 10.2

Proposition 10.9. *CAT(0)-spaces are uniquely geodesic.*

Proof. Let X be a CAT(0)-space and let $x, y \in X$. Let j_1 and j_2 be geodesic segments such that $j_1(0) = j_2(0) = x$ and $j_1(d(x, y)) = j_2(d(x, y)) = y$. Let $z = j_1(t)$, $0 \leq t \leq d(x, y)$ be in the image of j_1 and consider the triangle Δ whose vertices are x, y and z and whose sides are $j_1|_{[0,t]}$, $j_1|_{[t,d(x,y)]}$ and j_2 . The Euclidean comparison triangle of Δ is degenerate. As X is a CAT(-1) space, we get $d(j_1(t), j_2(t)) \leq \|\overline{j_1(t)} - \overline{j_2(t)}\| = 0$. Thus, $j_1(t) = j_2(t)$ for all $t \in [0, d(x, y)]$, which implies $j_1 = j_2$. \square

Proposition 10.10. *Balls are strictly convex in CAT(0) spaces.*

Proof. Exercise. \square

Proposition 10.11. *CAT(-1)-spaces are $\log(1 + \sqrt{2})$ -hyperbolic.*

Proof. Exercise. \square

A metric space X is *contractible* if there is a continuous mapping $F: [0, 1] \times X \rightarrow X$ such that $F(0, \cdot)$ is a constant mapping and $F(1, \cdot)$ is the identity mapping.^a

^aThe identity map is *null-homotopic*.

Proposition 10.12. *CAT(0)-spaces are contractible.*

Proof. Let $x_0 \in X$. For each $x \in X$, there is a unique geodesic segment $g_x \in \check{\mathcal{G}}_+(X, x_0)$ with $g_x(\infty) = x$ because X is uniquely geodesic by Proposition 10.9. Let $F: [0, 1] \times X \rightarrow X$,

$$F(t, x) = g_x(t d(x_0, x)).$$

For fixed $x \in X$, the mapping $t \mapsto g_x(t d(x_0, x))$ is an affinely reparametrized geodesic segment. By comparison with a triangle with vertices $\bar{x}_0 = 0, \bar{x}_1$ and \bar{x}_2 in \mathbb{E}^2 ,

$$\begin{aligned} d(F(t_1, x_1), F(t_2, x_2)) &= d(g_{x_1}(t_1 d(x_0, x_1)), g_{x_2}(t_2 d(x_0, x_2))) \\ &\leq \|t_1 \bar{x}_1 - t_2 \bar{x}_2\| \leq |t_1 - t_2| \|\bar{x}_1\| + t_2 \|\bar{x}_1 - \bar{x}_2\| \\ &\leq |t_1 - t_2| \|\bar{x}_1\| + \|\bar{x}_1 - \bar{x}_2\| = |t_1 - t_2| d(x_0, x_1) + d(x_1, x_2) \end{aligned}$$

for all $t_1, t_2 \in [0, 1]$ and all $x_1, x_2 \in X$. Thus, F is continuous. \square

Proposition 10.12 implies that the class of CAT(κ)-spaces with $\kappa < 0$ does not contain all Gromov-hyperbolic spaces because for example the bi-infinite ladder is Gromov-hyperbolic but not contractible.

Exercises

10.1. Prove Proposition 10.3.

10.2. Prove Proposition 10.10.

10.3. Prove Proposition 10.11.

10.4. Let X be a CAT(0)-space and let $p \in X$. Let $\rho_1, \rho_2 \in \mathcal{G}_+(X, p)$ be asymptotic rays. Prove that $\rho_1 = \rho_2$.

Chapter 11

The boundary at infinity of a CAT(-1)-space

In this chapter we study the boundary at infinity of a CAT(-1)-space. In particular, we define a Gromov product and a metric in the boundary at infinity.

11.1 Some hyperbolic geometry

In this section we prove that triangles with a short side and two long sides have very long thin parts.

Let L be a geodesic line in \mathbb{H}^n . Lemma 5.20(1) implies that for each $p \in \mathbb{H}^n$, there is a unique point $\pi_L(p) \in L$ for which $d(p, L) = d(p, \pi_L(p))$.

Lemma 11.1. *Let L be a geodesic line in \mathbb{H}^n . For any $p \notin L$, the geodesic arc $[p, \pi_L(p)]$ is orthogonal to L .*

Proof. Exercise. □

Let L be a geodesic line in \mathbb{H}^n . The map $\pi_L: \mathbb{H}^n \rightarrow L$ is the *closest point map* of L .

Proposition 11.2. *The closest point map π_L is 1-Lipschitz. More precisely, for any $p, q \in \mathbb{H}^n$,*

$$d(\pi_L(p), \pi_L(q)) \leq d(p, q)$$

with equality only if $p, q \in L$.

Proof. Normalize so that L is the geodesic line with endpoints at 0 and ∞ . For any $x \in L$,

$$\pi_L^{-1}(x) = \{y \in \mathbb{H}^n : \|y\| = \|x\|\}.$$

Let us minimize the hyperbolic distance between any pair of points $x, y \in \mathbb{H}^n$ such that $\pi_L(x) = \pi_L(p)$ and $\pi_L(y) = \pi_L(q)$. Recall from section 5.3 that

$$d(x, y) = \operatorname{arcosh} \left(1 + \frac{\|x - y\|^2}{2x_n y_n} \right).$$

The Euclidean distance $\|x - y\|$ is minimal when x and y are on the same ray from 0 and the product $x_n y_n$ is maximal when x and y are on L . \square

Lemma 11.3. *Let $p, q \in \mathbb{H}^n$ and let $\rho \in \mathcal{G}(\mathbb{H}^n, p)$. Let $\varepsilon > 0$. If*

$$\max \left(d(p, q), \log \frac{4 \sinh d(p, q)}{\varepsilon} \right) < t < T,$$

then $d(\rho(t), [q, \rho(T)]) < \varepsilon$.

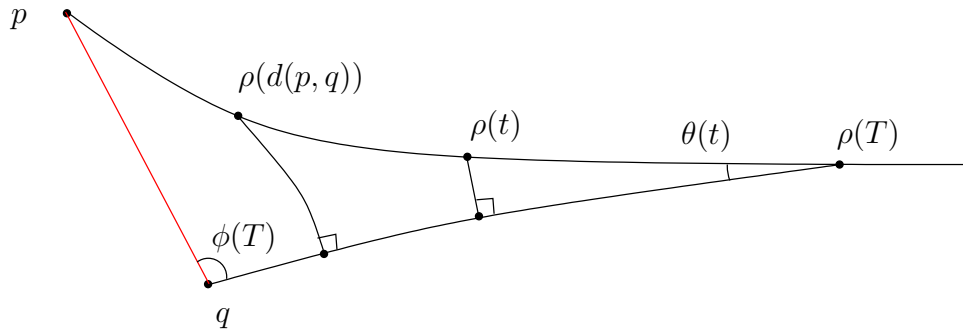

Proof. Let $\theta(T)$ be the angle at $\rho(T)$ and let $\phi(T)$ be the angle at q in the triangle with vertices p, q and $\rho(T)$. The hyperbolic law of sines¹ gives the equation

$$\sin \theta(T) = \frac{\sin \phi(T) \sinh d(p, q)}{\sinh T}.$$

Let L be the unique geodesic line that contains the geodesic segment $[q, \rho(T)]$. Lemma 11.2 implies that $d(\pi_L(\rho(t)), \rho(T)) \leq d(\rho(t), \rho(T))$. Thus $\pi_L(\rho(t))$ is the closest point to $\rho(t)$ in the segment $[q, \rho(T)]$. Lemma 11.1 implies that the segment $[\rho(t), \pi_L(\rho(t))]$ meets $[q, \rho(T)]$ orthogonally at $\pi_L(\rho(t))$.

The hyperbolic sine law applied to the triangle with vertices $\rho(t), \pi_L(\rho(t))$ and $\rho(T)$ implies

$$\sinh d(\rho(t), \pi_L(\rho(t))) = \frac{\sin \phi(T) \sinh d(p, q) \sinh(T - t)}{\sinh T} \leq \frac{\sinh d(p, q) \sinh(T - t)}{\sinh T}.$$

An elementary computation shows that the right side of this inequality is smaller than ε if $t > \log \frac{4 \sinh d(p, q)}{\varepsilon}$. The claim follows as $t < \sinh t$ for $t \geq 0$. \square

11.2 Asymptotic rays

In this section we collect some results on asymptotic rays in a CAT(-1). The first one strengthens the conclusion of Proposition 9.4 for these spaces.

Proposition 11.4. *Let X be a proper CAT(-1)-space and let $p \in X$ and $\xi \in \partial_\infty X$. There is a unique geodesic ray $\rho \in \mathcal{G}_+(X, p)$ with $\rho(\infty) = \xi$.*

¹Proposition 4.27

Proof. CAT(−1)-spaces are Gromov-hyperbolic by Proposition 10.11. Existence of the ray follows from Proposition 9.4. As X is a CAT(0)-space by Proposition 10.8, uniqueness of the ray follows from Exercise 10.4. \square

The estimate of Lemma 11.3 is very rough and an optimal value is not important for us. The important content of this result is that the lower bound on t depends only on $d(p, q)$ and ε . This is generalized in the following proposition:

Proposition 11.5. *Let X be a CAT(−1)-space. Let $p, q \in X$ and let $\varepsilon > 0$. There is some constant $M > 0$ such that if $w \in X$ with $d(p, w), d(q, w) \geq M$, $x \in [p, d(p, w)]$ with $M \leq d(p, x) \leq M$, then $d(x, [q, w]) \leq \varepsilon$.*

Proof. This follows directly by comparison from Lemma 11.3. \square

Proposition 11.6. *Let X be a CAT(−1)-space. Let $\rho_1, \rho_2 \in \mathcal{G}_+(X)$ with $\rho_1(\infty) = \rho_2(\infty)$.*

(1) $\lim_{t \rightarrow \infty} d(\rho_1(t), \rho_2) = 0$.

(2) *There is some $T \in \mathbb{R}$ such that $\lim_{t \rightarrow \infty} d(\rho_1(t), \rho_2(T + t)) = 0$.*

Proof. When X is proper, the claim follows by modifying the proof of Proposition 8.4 where δ -hyperbolicity is replaced by the thinness of long triangles given by Proposition 11.5. We leave the general case as an exercise. \square

11.3 The Busemann cocycle

In this section, we introduce the Busemann cocycle, and horoballs and horospheres that are subsets of the CAT(−1)-space defined using the Busemann cocycle. In Example 11.12, we find a geometric meaning in terms of horospheres for the spheres tangent to the boundary at infinity in the upper halfplane model and the Poincaré model of hyperbolic space.

Let X be a CAT(−1)-space. The *Busemann cocycle* of X is the map $\beta : \partial_\infty X \times X \times X \rightarrow \mathbb{R}$ defined by

$$(\xi, x, y) \mapsto \beta_\xi(x, y) = \lim_{t \rightarrow +\infty} d(\rho(t), x) - d(\rho(t), y),$$

where ρ is any geodesic ray ending at ξ .

Proposition 11.7. *Let X be a CAT(−1)-space. The Busemann cocycle is well-defined.*

Proof. Let $\rho \in \mathcal{G}_+(X)$. The function

$$t \mapsto f_x(t) = d(\rho(t), x) - t = d(\rho(t), x) - d(\rho(t), \rho(0))$$

is decreasing because if $t > s$, we have

$$d(x, \rho(t)) \leq d(x, \rho(s)) + d(\rho(s), \rho(t)) = d(x, \rho(s)) + t - s.$$

Furthermore,

$$t = d(\rho(0), \rho(t)) \leq d(\rho(0), x) + d(x, \rho(t)),$$

so that $d(x, \rho(t)) - t \geq -d(\rho(0), x)$ for all $t \geq 0$. Thus the limit $\lim_{t \rightarrow \infty} f_x(t)$ exists. As $\beta(\rho(\infty), x, y) = f_y(t) - f_x(t)$, the limit in the definition of the Busemann cocycle exists for a fixed ρ .

Let $\rho_1, \rho_2 \in \mathcal{G}_+(X)$ such that $\rho(\infty) = \rho'(\infty)$. By Proposition 11.6, we have

$$\lim_{t \rightarrow +\infty} d(\rho_1(t), x) - d(\rho_1(t), y) = \lim_{t \rightarrow +\infty} d(\rho_2(T + t), x) - d(\rho_2(t + T), y),$$

which shows that the definition of the Busemann cocycle is independent of the ray used in its definition. \square

Example 11.8. (1) Let $x = (\underline{x}, x_n), y = (\underline{x}, x_n) \in \mathbb{H}^n$ in the upper halfspace model. Let $\rho \in \mathcal{G}_+(\mathbb{H}^n, p)$, $\rho(t) = (\underline{x}, x_n e^t)$, and let $\xi = \infty = \rho(\infty)$. Theorem 4.12 and Proposition 5.9 give the estimates

$$t + \log \frac{x_n}{y_n} = d(\rho(t), \underline{y}, x_n e^t) \leq d(\rho(t), y) \leq d(\rho(t), (\underline{y}, x_n e^t)) + d(\underline{y}, x_n e^t, y)$$

for large t , which implies that

$$\beta_\infty(x, y) = \log \frac{y_n}{x_n}.$$

(2) If X is an \mathbb{R} -tree, if $p \in X$ is such that $[x, \xi[\cap [y, \xi[= [p, \xi[$, then

$$\beta_\xi(x, y) = d(x, p) - d(y, p). \tag{11.1}$$

Lemma 11.9. *If $x, y, z \in X$, $\xi \in \partial_\infty X$ and let $g \in \text{Isom}(X)$. Then*

- (1) $|\beta_\xi(x, y)| \leq d(x, y)$.
- (2) $\beta_{g \cdot \xi}(g(x), g(y)) = \beta_\xi(x, y)$.
- (3) $\beta_\xi(x, y) + \beta_\xi(y, z) = \beta_\xi(x, z)$.

Proof. (1) The triangle inequality gives the bounds

$$-d(x, y) \leq d(\rho(t), x) - d(\rho(t), y) \leq d(x, y)$$

for all $t \geq 0$.

(2) Exercise.

(3) Trivially, we have the equation $d(\rho(t), x) - d(\rho(t), y) + d(\rho(t), y) - d(\rho(t), z)$ for all $t \geq 0$. The claim follows by taking the limit $t \rightarrow \infty$. \square

Let X be a CAT(-1)-space. Let L be a geodesic line in X and let $\xi \in \partial_\infty X$ be one of its endpoints. The *horospherical^a projection map of L with respect to ξ* is the mapping $h_{L,\xi}: X \rightarrow L$ defined by setting $h_{L,\xi}(p)$ to be the unique point on L such that $\beta_\xi(p, h_{L,\xi}(p)) = 0$.

^aWhen $X = \mathbb{H}^2$, this mapping is usually called the *horocyclic* projection map.

Note that if $L =]\xi, \eta[$, the maps $h_{L,\xi}$ and $h_{L,\eta}$ are usually not the same mapping. See figure 11.1 for an example in the hyperbolic plane.

Proposition 11.10. *Let X be a CAT(-1)-space. Let L be a geodesic line and let $\xi \in \partial_\infty X$ be one of its endpoints. The horospherical projection $h_{L,\xi}$ is 1-Lipschitz. More precisely, for any $p, q \in X$,*

$$d(h_{L,\xi}(p), h_{L,\xi}(q)) \leq d(p, q)$$

with equality only if $p, q \in L$.

Proof. Exercise. □

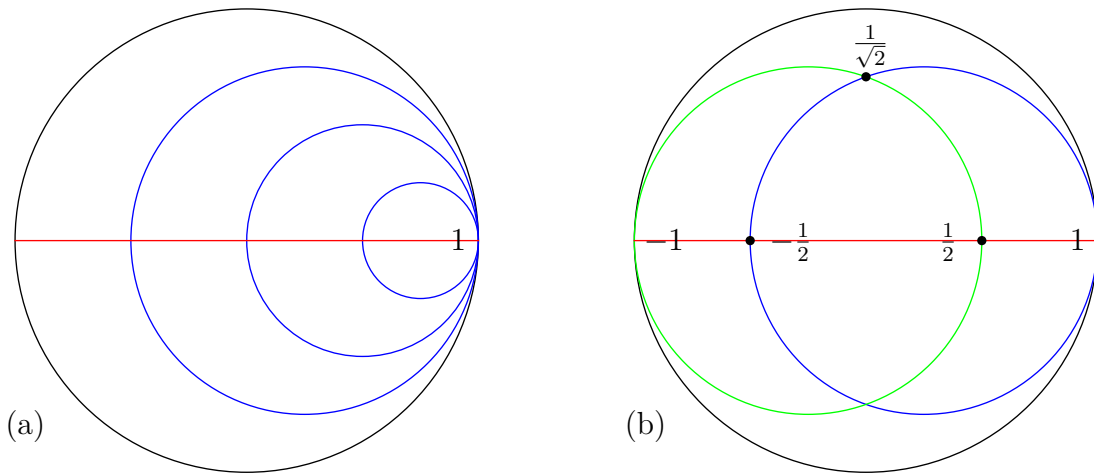

Figure 11.1 — (a) Horocycles centered at $1 \in \partial_\infty \mathbb{H}^2$ in the Poincaré model. (b) The horocyclic projections with respect to the two endpoints of the geodesic line $L =]-1, 1[$ are different in \mathbb{H}^2 : $h_{L,1}(\frac{1}{\sqrt{2}} = -\frac{1}{2})$ and $h_{L,-1}(\frac{1}{\sqrt{2}} = \frac{1}{2})$.

Let X be a CAT(-1)-space. Let $\xi \in \partial_\infty X$ and let $x \in X$. The (closed) horoball centred at ξ through x is

$$\mathcal{H}(\xi, x) = \{y \in X : \beta_\xi(x, y) \geq 0\},$$

and

$$\partial \mathcal{H}(\xi, x) = \{y \in X : \beta_\xi(x, y) = 0\},$$

the is the horosphere^a centred at ξ through x .

^aWhen $X = \mathbb{H}^2$, horospheres are usually called horocycles.

Proposition 11.11. *Let X be a CAT(-1)-space.*

- (1) *Horoballs are nonempty closed convex² subsets of X .*
- (2) *Let $\xi \in \partial_\infty X$ and let $x \in X$. If $g \in \text{Isom}(X)$, then $g(\mathcal{H}(\xi, x)) = \mathcal{H}(g \cdot \xi, g(x))$.*

Proof. (1) Exercise.

(2) This is a direct consequence of Lemma 11.9. □

²In fact, they are strictly convex.

Example 11.12. Let $x = (\underline{x}, x_n) \in \mathbb{H}^n$ in the upper halfspace model. Example 11.8 implies that

$$\mathcal{H}(\infty, x) = \{y \in \mathbb{H}^n : y_n \geq x_n\}.$$

For each $x \in \mathbb{R}^{n-1} \times \{0\} = \partial_\infty \mathbb{H}^n$, $x = T_x \circ \iota_{0,1}(\infty)$. The mapping $g_x = T_x \circ \iota_{0,1}$ is an isometry of \mathbb{H}^n and it is a composition of two reflections in hyperplanes and the inversion $\iota_{0,1}$. Thus, g_x maps the horoballs centered at ∞ to Euclidean balls that are tangent to $\partial_\infty \mathbb{H}^n$ at x . Proposition 11.11 implies that $g_x(\mathcal{H}(\infty, y)) = \mathcal{H}(x, g_x(y))$. In the ball model, horoballs are Euclidean balls tangent to $\partial_\infty \mathbb{H}^n = \mathbb{S}^{n-1}$.

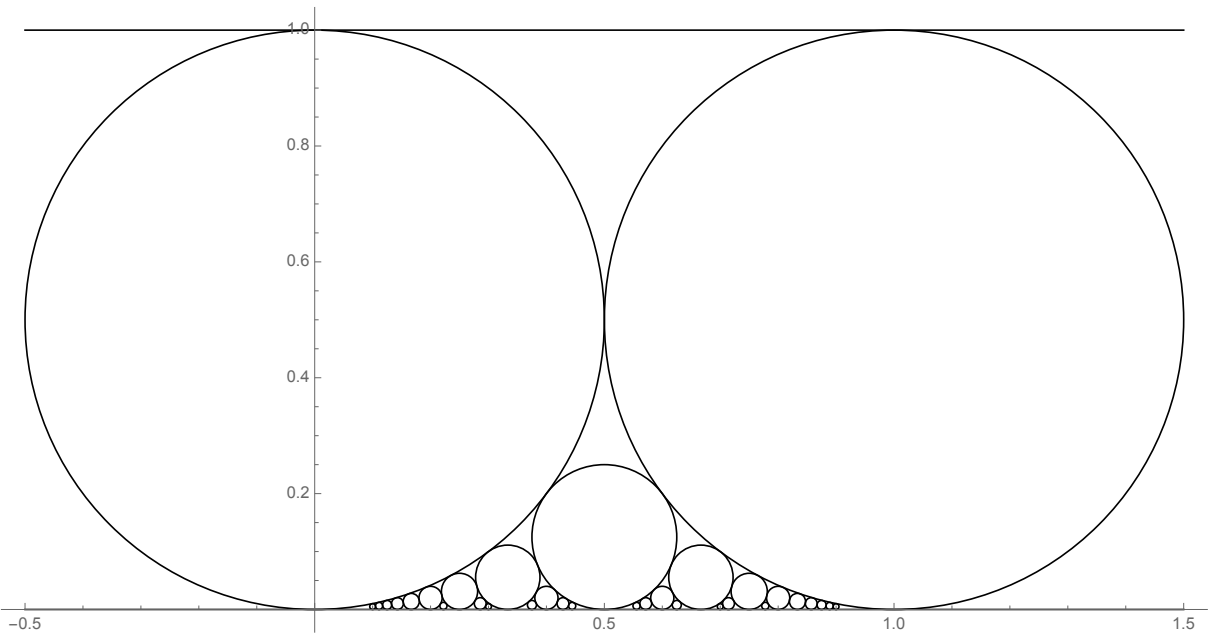

Figure 11.2 — Horoballs in the upper halfplane model of \mathbb{H}^2 .

11.4 Gromov product in the boundary at infinity

In section 8.3, we extended the Gromov product of an \mathbb{R} -tree to the boundary at infinity by a limiting construction. This is not possible for Gromov-hyperbolic spaces in general in such a simple manner, see Exercise 8.7. However, the construction works for CAT(-1)-spaces as we will now see.

Lemma 11.13. *Let X be a proper CAT(-1)-space, let $x_0 \in X$ and let $\xi_1, \xi_2 \in \partial_\infty X$. Let $\rho_1, \rho_2 \in \mathcal{G}_+(X, x_0)$ with $\rho_1(\infty) = \xi_1$ and $\rho_2(\infty) = \xi_2$. Let $p \in]\xi_1, \xi_2[$. Then*

$$\lim_{t \rightarrow \infty} (\rho_1(t) | \rho_2(t))_{x_0} = \frac{1}{2} (\beta_{\xi_1}(x_0, p) + \beta_{\xi_2}(x_0, p)).$$

Proof. Let $\gamma \in \mathcal{G}(X)$ such that $\gamma(-\infty) = \xi_1$ and $\gamma(\infty) = \xi_2$. Then,

$$\begin{aligned} \beta_{\xi_1}(x_0, p) + \beta_{\xi_2}(x_0, p) &= \lim_{t \rightarrow \infty} (d(x_0, \rho_1(t)) - d(\rho_1(t), p)) + \lim_{t \rightarrow \infty} (d(x_0, \rho_2(t)) - d(\rho_2(t), p)) \\ &= \lim_{t \rightarrow \infty} (d(x_0, \rho_1(t)) + d(x_0, \rho_2(t)) - (d(\rho_1(t), p) + d(\rho_2(t), p))) \\ &= \lim_{t \rightarrow \infty} (d(x_0, \rho_1(t)) + d(x_0, \rho_2(t)) - d(\rho_1(t), \rho_2(t))), \end{aligned}$$

where the final equation follows from Proposition 11.6. \square

Let X be a proper CAT(-1) space. The *Gromov product* of $\xi_1, \xi_2 \in \partial_\infty X$ with respect to $x_0 \in X$ is

$$(\xi_1 | \xi_2)_{x_0} = \lim_{t \rightarrow \infty} (\rho_1(t) | \rho_2(t))_{x_0},$$

where $\rho_1, \rho_2 \in \mathcal{G}_+(X, x_0)$ with $\rho_1(\infty) = \xi_1$ and $\rho_2(\infty) = \xi_2$.

As in the case of \mathbb{R} -trees, we use the Gromov product at infinity to define a metric:

Let X be a proper CAT(-1) space. The *Gromov-Bourdon visual metric* of $\partial_\infty X$ with basepoint x_0 is

$$d_{x_0}(\xi_1, \xi_2) = \begin{cases} e^{-(\xi_1 | \xi_2)_{x_0}} & \text{if } \xi_1 \neq \xi_2 \\ 0 & \text{if } \xi_1 = \xi_2. \end{cases}$$

Let $x_0, x_1, x_2 \in X$ and let $\bar{x}_0, \bar{x}_1, \bar{x}_2 \in \mathbb{H}^2$ be the vertices of the comparison triangle of x_0, x_1, x_2 . Let

$$\alpha_{x_0}(x_1, x_2) = \sin \frac{\sphericalangle_{\bar{x}_0}(\bar{x}_1, \bar{x}_2)}{2}$$

Lemma 11.14. *If X is a CAT(-1) space, $x_0 \in X$ and $t > 0$, then α_{x_0} is a metric in the sphere $\partial B(x_0, t)$*

Proof. The usual formulae of trigonometric and hyperbolic functions give

$$\begin{aligned} \alpha_{x_0}(x_1, x_2) &= \sin \frac{\sphericalangle_{\bar{x}_0}(\bar{x}_1, \bar{x}_2)}{2} = \sqrt{\frac{1 - \cos \sphericalangle_{\bar{x}_0}(\bar{x}_1, \bar{x}_2)}{2}} \\ &= \sqrt{\frac{\cosh d(x_1, x_2) - \cosh(d(x_0, x_1) - d(x_0, x_2))}{2 \sinh d(x_0, x_1) \sinh d(x_0, x_2)}}. \end{aligned}$$

Thus, if $d(x_0, x_1) = d(x_0, x_2) = t$,

$$\alpha_{x_0}(x_1, x_2) = \sqrt{\frac{\cosh d(x_1, x_2) - 1}{2 \sinh^2 t}}. \quad (11.2)$$

As the mapping $t \mapsto \sqrt{\cosh t - 1}$ on $[0, \infty[$ is increasing and convex and vanishes only at 0, we conclude that α_{x_0} is a metric. \square

Lemma 11.15. *Let X be a proper CAT(-1) space and let $\rho_1, \rho_2 \in \mathcal{G}_+(X, x_0)$. Then*

$$\lim_{t \rightarrow \infty} \alpha_{x_0}(\rho_1(t), \rho_2(t)) = d_{x_0}(\rho_1(\infty), \rho_2(\infty)).$$

Proof. Using equation (11.2), we have

$$\begin{aligned} \lim_{t \rightarrow \infty} \alpha_{x_0}(\rho_1(t), \rho_2(t)) &= \sqrt{\lim_{t \rightarrow \infty} \frac{\cosh d(\rho_1(t), \rho_2(t))}{2 \sinh^2 t}} \\ &= \sqrt{\lim_{t \rightarrow \infty} \frac{e^{d(\rho_1(t), \rho_2(t))}}{e^{2t}}} \\ &= e^{-(\rho_1(\infty) | \rho_2(\infty))_{x_0}}. \quad \square \end{aligned}$$

Proposition 11.16. *The Gromov-Bourdon visual metric is a metric.*

Proof. The properties of the metric on the expanding spheres are preserved in the limit. \square

Example 11.17. The visual distance $d_0(\xi_1, \xi_2)$ of two points $\xi_1, \xi_2 \in \partial_\infty \mathbb{H}^n = \mathbb{S}^{n-1}$ in the Poincaré ball model of \mathbb{H}^n is half the length of the Euclidean segment $[\xi_1, \xi_2]$.

Exercises

- 11.1. Prove Lemma 11.1.
- 11.2. Give a detailed proof of Proposition 11.6(1) for proper CAT(-1)-spaces.
- 11.3. Give a detailed proof of Proposition 11.6(2) for proper CAT(-1)-spaces.
- 11.4. Prove Proposition 11.6 without the assumption that X is proper.
- 11.5. Let X be a regular tree with constant degree 3, and let $x_0 \in VX$ and let $\xi \in \partial_\infty X$. Describe the horoball $\mathcal{H}(\xi, x_0)$. Draw a picture.
- 11.6. Prove Lemma 11.9(2).
- 11.7. Prove Proposition 11.10.
- 11.8. Prove Proposition 11.11(1).³

³It is sufficient to use that X is a CAT(0)-space.

Appendix B

Complements on topology

B.1 Topology of compact convergence

Let X be a topological space and let Y be a metric space. A sequence $(f_k)_{k \in \mathbb{N}}$ of mappings $f_k: X \rightarrow Y$ converges uniformly on compact sets to a mapping $f: X \rightarrow Y$ if the sequence $(f_k|_K)_{k \in \mathbb{N}}$ converges uniformly for compact subsets $K \subset X$.

Uniform convergence on compact subsets defines a topology on the space of continuous mappings.

Let X be a topological space and let Y be a metric space. For $f \in C(X, Y)$, $K \subset X$ compact and $\varepsilon > 0$, let

$$B_K(f, \varepsilon) = \{g \in C(X, Y) : \max_{x \in K} d(f(x), g(x)) < \varepsilon\}.$$

The topology generated by

$$\{B_K(f, \varepsilon) : f \in C(X, Y), K \subset X \text{ compact}, \varepsilon > 0\}$$

is the topology of compact convergence in $C(X, Y)$.

Proposition B.1. *Let X be a topological space and let Y be a metric space. A sequence of functions $(f_k)_{k \in \mathbb{N}}$, $f_k \in C(X, Y)$ converges uniformly on compact sets if and only if it converges in the topology of compact convergence.*

Proof. Exercise. □

B.2 The theorems of Arzelà and Ascoli

Let X be a topological space and let Y be a metric space. A subset $\mathcal{F} \subset C(X, Y)$ is equicontinuous if for all $x_0 \in X$ for all $\varepsilon > 0$ there is an open neighbourhood of x_0 such that $d(f(x), f(x_0)) < \varepsilon$ for all $f \in \mathcal{F}$.

Example B.2. If (X, d_X) and (Y, d_Y) are metric spaces, the family M -Lipschitz mappings

$$\text{Lip}_M(X, Y) = \{f: X \rightarrow Y : d_Y(f(x_1), f(x_2)) \leq M d_X(x_1, x_2) \text{ for all } x_1, x_2 \in X\}$$

is equicontinuous: the condition $d_X(x_1, x_2) < \frac{\varepsilon}{M}$ implies $d_Y(f(x_1), f(x_2)) < \varepsilon$ for all $f \in \text{Lip}_M(X, Y)$ and all $x_1, x_2 \in X$.

Theorem B.3 (Arzelà and Ascoli). *Let X be a topological space and let Y be a metric space. Let $\mathcal{F} \subset C(X, Y)$ be a subset that consists of equicontinuous mappings such that the sets $\mathcal{F}_x = \{f(x) : f \in \mathcal{F}\}$ have compact closures for all $x \in X$. Then \mathcal{F} is contained in a compact subset of $C(X, Y)$.*

Proof. See [Mun, Thm. 47.1]. □

Corollary B.4 (Arzelà and Ascoli). *Let X be a topological space and let Y be a metric space. Let $\mathcal{F} \subset C(X, Y)$ be a closed subset that consists of equicontinuous mappings such that the sets $\mathcal{F}_x = \{f(x) : f \in \mathcal{F}\}$ have compact closures for all $x \in X$. Then \mathcal{F} is compact.* □

Another version of the theorem of Arzelà and Ascoli that one often sees is also useful.

Let (X, d_X) and (Y, d_Y) be metric spaces. A family $\mathcal{F} \subset C(X, Y)$ is *uniformly equicontinuous*^a if for all $\varepsilon > 0$ there is $\delta > 0$ such that $d_Y(f(x), f(y)) < \varepsilon$ for all $f \in \mathcal{F}$ when $d_X(x, y) < \delta$.

^aBeware of the terminology: [BH] call this property *equicontinuity*.

Theorem B.5 (Arzelà and Ascoli). *Let X be a separable metric space and let Y compact metric space. Any sequence $(f_k)_{k \in \mathbb{N}}$, of uniformly equicontinuous mappings $f_k: X \rightarrow Y$ has a subsequence that converges uniformly on compact subsets. The limit mapping is uniformly continuous.*

Proof. See [BH, Lemma I.3.10]. □

B.3 Quotient mappings

If X is a topological space and \sim is an equivalence relation in X , the quotient set X/\sim has a natural *quotient topology*, where $V \subset X/\sim$ is open if and only if its preimage in X is open. See for example [Mun, §22].

Let X and Y be topological spaces. A mapping $q: X \rightarrow Y$ is a *quotient map* if it is a continuous surjection and $q^{-1}(U)$ is open only if U is open.

Lemma B.6. *A continuous surjection $q: X \rightarrow Y$ is a quotient map $q^{-1}(F)$ is closed only if F is closed.*

Proof. Exercise. □

Surjective continuous maps that are open or closed are quotient maps but not all quotient maps are open or closed mappings.

Proposition B.7. *Let X and Y be topological spaces and let $q: X \rightarrow Y$ be a continuous surjection. Let \sim be the equivalence relation in X defined by setting $x \sim x'$ if and only if $q(x) = q(x')$. The spaces Y and X/\sim are homeomorphic if and only if q is a quotient map.*

Proof. See [Mun, Cor. 22.3]

□

Exercises

B.1. Prove Proposition B.1.

B.2. Prove Lemma B.6.

Appendix C

Projects

Writing a report on one of the *projects* below is part of the requirement for passing the course in addition to getting at least 50% for the exercises. The aim of each project is to study the material using the given sources, or any other source, and to write a presentation in a style compatible with this course.

The projects should be completed by the end of January 2021. If you finish earlier, you can of course return the project earlier and get credit for the course earlier.

It is possible that more options for the projects appear in the last two weeks of the course.

If you do not have access to the literature indicated in the project descriptions, let me know. Note that [Mun] is available at the internet library <http://archive.org>.

C.1 The theorem of Arzelà and Ascoli

Study the proof of Theorem B.3 for example using [Mun, Thm. 47.1], and write a presentation where you introduce the required required material etc. You may assume that Tychonoff's theorem is known but include its statement in the presentation.

C.2 The 4-point condition

A geodesic metric space X satisfies the *4-point condition* with constant $\delta > 0$ if

$$(x | y)_w \geq \min((x | z)_w, (y | z)_w) - \delta$$

for all $x, y, z, w \in X$.

Theorem C.1. *A geodesic metric space X is Gromov-hyperbolic if and only if it satisfies the 4-point condition with some constant $\delta > 0$.*

Study the proof of Theorem C.1 from [BS, §2.1] or [BH, p. 410-411].

C.3 Metrically convex spaces

There are other notions of non-positive curvature than the CAT(0)-condition. A slightly weaker one is the convexity of the metric.

A geodesic metric space X is *metrically convex* if for any two affinely reparametrized geodesic segments $j_1, j_2: [0, 1] \rightarrow X$, the function $t \mapsto d(j_1(t), j_2(t))$ is convex.

Introduce the concept of metric convexity and prove that normed spaces and CAT(0)-spaces are metrically convex. Prove also that metrically convex spaces are contractible. Material for this project is found at [BH, Prop. II.2.2] and in Section 8.1 of [Pap], in particular, Proposition 8.1.8.

Bibliography

- [And] J. W. Anderson. *Hyperbolic geometry*. Springer Undergraduate Mathematics Series. Springer-Verlag London Ltd., London, second edition, 2005.
- [Bea] A. F. Beardon. *The geometry of discrete groups*, volume 91 of *Graduate Texts in Mathematics*. Springer-Verlag, 1983.
- [Bou1] N. Bourbaki. *General topology. Chapters 1–4*. Elements of Mathematics. Springer-Verlag, Berlin, 1998.
- [Bou2] N. Bourbaki. *General topology. Chapters 5–10*. Elements of Mathematics (Berlin). Springer-Verlag, Berlin, 1998.
- [BH] M. R. Bridson and A. Haefliger. *Metric spaces of non-positive curvature*, volume 319 of *Grundlehren der Mathematischen Wissenschaften*. Springer-Verlag, 1999.
- [BS] S. Buyalo and V. Schroeder. *Elements of asymptotic geometry*. EMS Monographs in Mathematics. European Mathematical Society (EMS), Zürich, 2007.
- [EO] P. Eberlein and B. O’Neill. Visibility manifolds. *Pacific J. Math.*, 46:45–109, 1973.
- [GdlH] É. Ghys and P. de la Harpe, editors. *Sur les groupes hyperboliques d’après Mikhael Gromov*, volume 83 of *Progress in Mathematics*. Birkhäuser Boston, Inc., Boston, MA, 1990.
- [HY] J. G. Hocking and G. S. Young. *Topology*. Dover Publications, Inc., New York, second edition, 1988.
- [Mun] J. R. Munkres. *Topology*. Prentice Hall, Inc., second edition, 2000.
- [O’N] B. O’Neill. *Semi-Riemannian geometry*, volume 103 of *Pure and Applied Mathematics*. Academic Press, Inc. [Harcourt Brace Jovanovich, Publishers], New York, 1983. With applications to relativity.
- [Pap] A. Papadopoulos. *Metric spaces, convexity and nonpositive curvature*, volume 6 of *IRMA Lectures in Mathematics and Theoretical Physics*. European Mathematical Society (EMS), Zürich, 2005.

-
- [Pet] P. Petersen. *Riemannian geometry*, volume 171 of *Graduate Texts in Mathematics*. Springer, New York, second edition, 2006.
- [Rot] J. J. Rotman. *An introduction to the theory of groups*, volume 148 of *Graduate Texts in Mathematics*. Springer-Verlag, New York, fourth edition, 1995.
- [Ser] J.-P. Serre. *Trees*. Springer Monographs in Mathematics. Springer-Verlag, Berlin, 2003.